

# DICTIONARY of PYROTECHNICS

A complete Manual covering the authors work  
and experiments from 1890 to 1930.

\*\*\*\*\*

A drop of ink, t'is said  
made millions think;

A spark of fireworks has oft  
made thousands blink.

\*\*\*\*\*



Though handicapped in the struggle of life, I have achieved some small success through the constant untiring assistance of my wife. As a slight token of appreciation I dedicate to her this work.

The Author





I N T R O D U C T I O N .

---

In the following work, the object has been to place on file a complete record of the development of the Art of Pyrotechny up to the present time. The great steps in modern fireworks making seem to be marked by Ruggieri in 1812; Chertier in 1854; Kentish in 1878 and Antoni in 1893. The writer has been unable to locate anything comprehensive on the subject since the latter date, yet, in the interim great strides have been made, both in the materials used as well as in the methods employed in mass production of articles in general use for celebrations by the public. Powdered aluminum has added many beautiful effects; Picric acid is extensively used and compositions combining chlorate of potash and sulphur or its derivatives have, with the one exception of maroon composition, been practically eliminated, thus greatly reducing the danger of fire from friction and almost entirely that from spontaneous combustion.

The formulas herein given are all taken from those in actual use and will positively produce the effects for which they are indicated. The machines and tools shown are those in use in the most recently equipped factories.

A caution added here might not be amiss. Never hold any kind of fireworks in the hand while burning it. Make this rule without exception because sometimes the most

unexpected explosions occur and cause painful injury. In firing shells, be sure never to look into the mortar after the shell has been inserted. A spark might have in some manner gotten inside. Also never allow the arm or hand to come over the muzzle of the mortar. Long sections of bare match should be used on shells so that the one lighting them has ample time to reach a safe distance in case of the bursting of the gun. There is always enough danger, so avoid every unnecessary risk.

In conclusion I might add that in this work, pyrotechny is presented rather as a craft than as an art. For the artistic feature, imagination only is requisite but to work out the results of imagination is just plain tedious, patient and often thankless work. Consequently, if we have the methods at hand it will be easier to bring to life the artistic ideas.

P A R T II N G R E D I E N T S

## SALTPETER

( Potass Nitrate, Nitre)

This most important ingredient is made in New York State, of so high a quality that it is needless to look for better. I have always used the double refined, powdered, which can be obtained at from 5¢ to 15¢ lb. in barrels of 350 lbs. For some large work granulated salt-peter is advantageously used, burning slower and being at the same time cheaper. The most suitable is "Dupont #2".

POTASSIUM CHLORATE (K Cl O<sub>3</sub>)

This very necessary chemical is now also being made in this country of an excellent quality. The price however, varies considerably though it usually declines somewhat after July 4th. The powdered, ranges from 9¢ to 16¢ lb. in kegs of 112 lbs.

POTASSIUM PER-CHLORATE. (K Cl O<sub>4</sub>)

This substance forms another valuable addition to the pyrotechnists bag of tricks. Containing even more oxygen than the chlorate it is less liable to decomposition and is consequently safer to use. It can be substituted for the chlorate in most mixings and may be

safely used in connection with sulphur. In price it is somewhat more expensive than the chlorate.

#### SULPHUR

The "flowers" of sulphur, which is used almost exclusively is made of good quality in New York State also, and is sold for about 3¢ lb. in barrels of 250 lbs. Italian WASHED SULPHUR is recommended by some of the older English pyrotechnists for use with chlorate of potash but the writer never uses formulas containing the two substances, if possible. It is almost white and comes in bags of 50 lbs.

Sulphur "flower" is also sometimes used as well as coarsely ground sulphur, which burns somewhat slower than the first two varieties.

#### CHARCOAL

Willow coal is the best for fireworks purposes though coal made from any soft wood is suitable. Pine coal is not very desirable. Excellent charcoal is made near Rochester, N. Y. and can be had finely powdered, granulated or mixed @ 1½¢ lb. in barrels or sacks.

#### LAMP BLACK

Germantown lampblack is very popular with pyrotechnists though there are a number of good brands on the market, To make a good clear star it should be free from oil or other impurities and I have been compelled at times to bake it, as will later be explained, in order to get rid of volatile impurities which impair its brilliancy in burning. It can be bought in barrels of 1 lb. packages @ 3¢ lb.

### SHELLAC

This article is imported and is very hard to get really clean when powdered. As it is almost impossible to power it oneself without machinery it must be bought already powdered and is almost always adulterated with sand etc. It costs usually about 25¢ a lb.

For the best work shellac is almost indispensable but for stock goods, tableau fires, torches and many other uses a number of other gums have been introduced, such as Kouri Gum, a fossil rosin of light yellow color; Sheel-lac, Red Gum, Copal and several others, mostly mined in the Sandwich Islands. Besides these are used powdered Gum Asphaltum which produces excellent colors, but owing to its containing sulphur or on account of being so easily decomposed, it is liable to produce spontaneous combustion when mixed with chlorate of potass. A mixture of these two will explode violently when struck with a hammer on an anvil. With Potass perchlorate, however, it is entirely safe. So called Green Gum which is simply ground coconut shells, is used as an adulterant or filler for colored fires etc. to make them bulky and is therefore not to be classed among gums proper. Fine dry sawdust is also used for the latter purpose. Even flour and sugar of milk are sometimes used as sources of carbon. Another article of this character is

### STEARINE

In making blue fires it has been found that stearine produces a better effect, especially with paris

green and copper carbonate than most any of the other hydrocarbons. It is mostly obtained in cakes and is reduced to a serviceable condition by setting a carpenters plane, upside down over a box and shoving the cakes over the blade so as to shave the stearine as fine as possible. When it is then mixed with the other ingredients it will pass through an ordinary sieve.

#### NITRATE OF STRONTIA

This substance is made principally in England and Germany and comes to this country in kegs of 110 lbs. and in casks of 600 lbs. in a sufficiently pure condition for use as received, costing here from 6¢ to 8¢ a lb. It is probably the most useful color producing chemical used in fireworks making as the deep red light which it gives is the most marked effect which the pyrotechnist has achieved. Owing to its deliquescent properties, however, a number of methods have been devised to overcome this tendency among the most prominent of which is to melt in an iron pot over a fire some shellac and stir in nitrate of strontia, cooling and pulverizing. Another plan is to use Carbonate of strontia but at the cost of considerable depth of color.

#### CARBONATE OF STRONTIA

In damp climates there is no alternative for use of this strontium compound for most exhibition work as a piece of lancework made with nitrate of strontium,

if exposed for one hour to a damp atmosphere, will hardly burn. Precipitated carbonate of strontia is the only kind which should be used and may be purchased for about 16¢ lb. or can be easily made by adding carbonate of ammonia to a solution of Strontium nitrate, thoroughly washing and drying the precipitate. If sodium bicarbonate is used as a precipitant it is almost impossible to so thoroughly remove every trace of it from the carbonate of strontia as to cause an orange tint when used.

#### NITRATE OF BARYTA

Like strontia this chemical also comes to us mainly from England and Germany in similar packages and costs usually from 5¢ to 7¢ a lb. on this side. As a color producer it is far inferior to strontia though it does not attract moisture. If used without calomel its green color is so pale as to be hardly distinguishable from white. A better salt for making green fire is

#### CHLORATE OF BARYTA

This gives a very beautiful emerald color but its high cost, viz: about 30¢ lb. makes it little used except in exhibition work. I have seen recipes containing Boracic Acid, Thallium salts and other substances for producing green fire but have never used them myself or known anyone who did.

#### OXALATE OF SODA

It is a strange fact that while yellow is the most common color of fires in general, its practical production in pyrotechny is accompanied with some difficulty from the fact that there is practically only one insoluble salt of

sodium while all the others are more or less hygroscopic. The nitrate and bi-carbonate give deep yellow lights but the least dampness will render them incombustible and even the oxalate will, in damp weather, attract moisture. The exception is Sodium metantimonate but as this salt costs \$4.00 lb. and at best gives a pale color, it is not much used. Oxalate of soda costs about 20¢ lb. or can be easily made by adding bicarbonate of soda to a hot concentrated solution of oxalic acid. A copious precipitate falls which, however, cannot be washed but must be dried on a filter. An excess of oxalic acid should be maintained in this operation.

#### PARIS GREEN

This article is made in New York state and elsewhere in this country and can be bought for 10 to 15¢ lb. from dealers in paints. It can be easily made by adding a solution of blue-stone to one of arsenious acid, washing and drying the resultant bulky precipitate. It is used in making blue fire.

#### ANTIMONY

Metallic or Reglus antimony, when finely powdered in an iron mortar is used for making white fire. It may be had from machinery dealers @ 6¢ to 7¢ lb.



### SULPHURET OR BLACK ANTIMONY

This is handled by most drug dealers and costs 6¢ to 8¢ lb. but is often so impure as to be entirely useless. It is used in making white fire, maroons and other effects. Red and orange sulphurets are occasionally used also.

### RED ARSENIC, REALGAR, ORPIMENT

This mineral comes mostly from Hungary, in iron kegs of several hundred pounds and ranges in price from 6¢ to 9¢ lb. for the powdered. It is useful for making white stars especially as these take fire far more easily than those made from antimony etc. It is also used for making yellow smoke in day fireworks.

### COPPER CARBONATE

This substance is used for making blue fires but better effects are obtained by the use of other copper compounds, with less trouble. The native carbonate is almost useless for fireworks purposes but the precipitated is easily obtained from dealers in pyrotechnical chemicals or can be made by adding carbonate of ammonia to a solution of blue-stone. Chertiers Copper, is made by adding aqua

ammonia carefully to a solution of blue-stone, evaporating and crystalizing. Black sulphuret of copper and several other copper compounds are occasionally used. Also Black oxide of Copper.

### SULPHATE OF COPPER

For most purposes where a good blue is required in exhibition work this salt will serve the needs but owing to its being a sulphate great care must be taken in mixing it with chlorate of potash and a separate sieve should be used for mixtures of these substances, which should not be employed in any other work. It costs usually 10¢ to 15¢ lb. Mixtures containing it must not be stored but used promptly after making. Exposure to moist air oxidizes this salt and releases sulphuric acid. This can be obviated by using Potass perchlorate but the resulting mixtures are much more difficult to ignite in the form of stars etc.

### MAGNESIUM

#### ALUMINUM

When about 40 years ago it was found that a star of unusual brilliancy could be produced by the use of magnesium this metal suddenly came into considerable demand in spite of its then cost of \$75.00 lb. but about the time this price was reduced to \$5.00 lb. it was found that aluminum was in every way better and cost little more than \$1.00 lb. in fine powder. It can now be gotten from most paint dealers in 1 lb. cans or paper @ 60¢ lb.

CALOMEL

Is used to deepen the color of fires when not sufficiently deep without its use. It has been found that the chlorides of metals give the best spectrum but the chlorides are not usually applicable for fireworks making so the object of the addition of an easily decomposed chloride to fireworks compositions is to produce a chloride at the moment of combustion, thereby acquiring the desired result. Finely divided metals also take fire spontaneously in chlorine gas and the great heat thereby produced probably causes the increased depth of color. Calomel is made in Philadelphia and elsewhere and the cost was 65¢ to 70¢ lb. but has been recently advanced.

CHLORIDE OF AMMONIA

( Sal Ammoniac)

Is sometimes used as a substitute for calomel but its affinity for moisture seriously interferes with its general use. The crystalized ammonium chloride is almost useless, containing too much water of crystalization.

DEXTRINE

In all the old works on pyrotechny, either a solution of shellac in alcohol or gum arabic in water is used to bind compositions for making stars and other similar purposes but at present in many cases the necessary amount of dextrine is added at once to the mixture and then nothing but water is needed to form it into the desired objects. Dextrine also improves the color of some fires. It may be

advantageously used in place of glue for light work.

Potato dextrine usually comes in sacks of about 200 lbs. and costs from  $2\frac{1}{2}\text{¢}$  to  $5\text{¢}$  lb. When used for gumming rocket sticks, tabs etc., it is simply mixed with cold water to the desired consistency.

#### STEEL FILINGS - CAST IRON BORINGS - ETC.

A beautiful scintillating effect is produced with steel filings used in various ways. The Japanese make a little tube of twisted paper at one end of which is a composition which, when lighted produces a glowing bead of molten flux. The balance of the tube contains steel filings which, when reached by the fusing bead, burst into feather like flashes. In other countries steel filings are added to gerbs, fountains and driving cases with resulting great brilliancy. A beautiful waterfall effect is produced by charging from 50 to 200 cases 2 inches in diam. and 12 inches long with a composition containing cast iron borings. These are fastened to scantlings at intervals of about 15 inches, each scantling holding about 16 gerbs. These are matched and hoisted to a wire cable some 50 feet above the ground. When burned, the effect is most realistic as the arc of the suspended wire gives just the right curve to cause the appearance of perspective while the roar of the burning gerbs is also characteristic of Niagara Falls as the fire from the iron borings falls to the ground.

The best steel filings for gerbs is known as "needle steel". This resembles broken sewing needles but

is really a by-product of some planing or turning operations. Steel filings from saw filing shops are quite good provided they are the result of hand filing and not the particles thrown off by emery wheels. The latter are almost useless for pyrotechnical purposes.

When steel filings are added to gorb compositions, the saltpeter quickly attacks them frequently causing the gorb to become quite hot. The steel is rusted and this action practically destroys its usefulness. To avoid this the steel must be coated in some way to prevent the saltpeter from attacking it. This may be accomplished as follows:

In an agate-ware saucepan place a piece of parafine and carefully melt it, heating as much as possible without permitting it to smoke. To this add clean steel filings, as much as the parafine will thoroughly coat. There should be no surplus of parafine but just enough to completely cover each filing. Shake the pan and stir frequently while cooling to prevent the filings from caking.

Steel filings are also used in stars for rockets and shells.

#### CLAY

This is used for closing the ends of most cases as well as choking them when they are not crimped. Most any kind of clay will do. It must be thoroughly dried, pulverized and sifted. Before using it may be very slightly dampened. For convenience, where a large

quantity is required, powdered fire clay in barrels may be used as this saves the rather tedious job of drying and powdering.

#### GLUE

Several forms of glue are used in fireworks making. For attaching lances to framework a good grade of carriage glue is best. For attaching mine bottoms etc., to the mortars cheap carpenters glue will suffice. For placing shell fuses and securing the ends of cannon crackers good liquid glue is most convenient.

#### GUM ARABIC

In powdered form this is used in some star compositions, especially for making Japanese Stars. It is also used in "Son of a Gun" composition.

#### GUN POWDER

This is used in all grades from Dupont FFF Rifle to the coarse grains as large as cracked corn, for shells. A slow burning powder is preferable for a driving charge as it reduces the liability of shells bursting in the mortar.

#### MEAL POWDER

This article is used considerably in display work for gerbs etc., and in shells and rockets for a blowing charge. It is generally supplied in 25 lb. wooden kegs but is sometimes difficult to obtain. For that reason some pyrotechnists make a fairly good article themselves as follows:

Mount a 50 gallon wood barrel on two uprights so that it will revolve freely in centers fastened to the heads. On one center attach a crank and cut a hole into side of barrel suitable for putting in and removing the necessary ingredients. Place in the barrel 300 to 500 lead balls about 1 inch diam. When it is desired to make meal powder put into the barrel a thoroughly mixed composition as follows:

Salt peter, dbl. ref.	15 lbs.
Charcoal, willow	3 "
Sulphur Flowers	2 "

The barrel is now revolved for about 500 turns. The longer it is turned, the stronger the powder will become. Great care must be exercised that no foreign matter such as nails, gravel etc. find their way into the barrel as this might result in an explosion.

### NEW INGREDIENTS

Some years ago powdered magnesium was added to the articles used in pyrotechny and very fine bright effects were produced with it. However, its high price coupled with its affinity for oxygen, making it liable to take fire prematurely or decompose the chemicals mixed with it have caused its practical elimination. In the meantime aluminum, being produced in such large quantities at a low price was found to be able to duplicate all the effects of magnesium and many more besides. Added to colored stars and torches it greatly increases their brilliancy and beauty. Exquisite waterfall effects are produced with it as well as comets and tailed stars.

For a time large quantities of the finely divided aluminum (pyroaluminum) were used in the new flash crackers and the same composition was used in maroon shells. Besides increasing the report it gives a startlingly bright flash to the explosion. Being unaffected by water it is likewise much safer to handle than magnesium but care should be exercised in using it because as before mentioned, all finely divided metals are liable to explosion when in contact with oxygen producing chemicals.

Picric Acid is another valuable ingredient in fireworks making. When added in small quantities to colors it deepens them and increases their brilliancy without making them burn much faster. Likewise beautiful colors can be produced with it almost entirely free from smoke. But it must always be kept in mind that picric acid, (Triaitro-phenol is a first cousin to T. N. T. whose tremendous explosive force is well known. For this reason it cannot be used in shells as stars made with it will detonate when confined, instead of burning. Another effect for which large quantities of this substance was used until some years ago when a fatal accident occurred in a factory employed exclusively in making them, are the amusing WHISTLING FIREWORKS. Picrate of potass has the peculiar property of emitting a shrill whistling sound when rammed tightly and burned in a small tube. When made in small quantities and carefully handled it seems to be reasonably safe but the result of a barrel of it accidentally detonated can be readily imagined.



Another substance producing a most beautiful effect when fired from specially prepared rockets as will be explained later in detail, is phosphorus. It is with this that the so called "liquid fire" is made. This is an intensely yellow flame melting as it falls through the air into myriads of incandescent particles with a heavy background of white smoke. Obviously, the greatest care must be exercised in its use as phosphorus burns, even when very small, are most painful.

Considerable quantities of phosphorus are also used in the manufacture of the article variously known as "spit devil", "Son of a gun" etc. Deaths of children by poisoning on account of mistaking these tablet looking contrivances for candy and eating them has caused their restriction in many states.

AMORPHOUS PHOSPHORUS is the base of most of the toy torpedoes in use. Fulminate of Silver which was used almost exclusively for this purpose 40 years ago is now almost obsolete owing to its very sensitive nature. However, its method of preparation and use will be given later as a matter of record.

ZINC powder is used to some extent for making what is known as Electric Spreader Stars. These produce an original effect, breaking up while burning into many small bluish-green particles. These, being propelled with considerable force give the appearance of electrical discharges, hence the name. On account of the explosive nature of zinc dust the making of this star must be done with

caution and reserve until it is better understood.

An effect that is always beautiful, is easily produced, is perfectly safe under all circumstances and is susceptible of an infinite variety of uses is the Japanese or Lampblack star. The well known Willow Tree rockets and shells are made with it and it may be used as garniture for colored rockets, mines etc. An unusual fullness is given to any article to which a small quantity of Jap. star is added.

P A R T    IIM A N I P U L A T I O N

Unfortunately, it is impossible, entirely to remove the element of danger, either from the manufacture or use of fireworks. Even, with the greatest care accidents will occur to both those employed in making fireworks as well as to those burning them. It is here endeavored to point out the most fruitful sources of accident though obviously it is impossible to foresee every instance in which some carelessness or unknown fact may bring on disaster.

In the first place, always keep in mind that any mixture containing chlorate of potass and sulphur, a sulphide or a sulphate is liable to spontaneous combustion for the reason that under certain circumstances, through oxidation or otherwise, minute quantities of sulphuric acid are liberated, which, acting on the chlorate of potass will cause instant ignition. To prevent this condition from occurring unintentionally it must be kept in mind that entirely separate places, a considerable distance apart, be used for making so called "plain mixings" as rocket, roman candle and gerb composition containing sulphur, and the "colored mixings" containing chlorate of potass. Separate sieves and utensils of every description must be employed and those working in the "plain" sections of the factory must not go into the rooms of those in the "colored" section.

Second, keep in mind that very slight friction will sometimes start the burning of mixtures of finely divided chemicals. Star composition has been known to explode while being sifted, by scratching the brass sieve bottom with the finger nail, while rockets have taken fire from the solid brass rammer striking the top of the spindle while ramming.

Third, finely divided metals, when in contact with chlorate of potass sometimes take fire suddenly. While, fortunately this is seldom the case it must not be lost sight of. Even steel filings and iron borings frequently become quite warm when mixed with saltpeter, etc., and rammed into gerbs. Fire has said to have occurred from this action. In the subsequent chapter it will be explained how this latter can be entirely avoided. ( See Steel Filings ).

Employees in the mixing and ramming rooms of factories should be required to wear rubber shoes while at work, and a constant source of danger is the carrying of matches. This cannot even be controlled by requiring the employes to change their clothes in the factory before going to work and having them wear garments without pockets as they will sometimes slip out for a smoke during rest hours and have matches secreted somewhere about their persons.

Small buildings should be supplied, about 12 feet square and not less than 50 feet apart, for all those engaged in mixing and ramming operations as well as for those making stars, and as much as possible have one person to a room. Doors should be placed at both ends of work rooms and

should always open to the outside with no fastenings on the inner side but held closed, if desired, by spring hinges. Firebuckets inspected daily, should be on each building supplemented by fire hose conveniently placed for emergency.

The most successful method of reducing the liability of serious accidents to a minimum is to keep at all times the least possible amount of composition on hand in the work rooms and to remove to storage or finishing rooms all rammed articles as quickly as they accumulate.

When experimenting with new substances use the smallest possible amounts of the component chemicals until the entire safety of the mixture is assured. Before using considerable quantities of new mixtures they should be subjected to exhaustive tests as friction, percussion, detonation and moisture with subsequent drying. Also their flash point should, if possible, be ascertained with suitable apparatus for this purpose.

### M I X I N G

The first operation in fireworks making and I may say the most important is mixing. Chemicals are so well made now and can be so easily obtained in a powdered state that long articles on purifying, powdering etc., are unnecessary. All chemicals should, of course, be obtained of the best quality procurable at a reasonable price and as finely powdered (as a general thing) as possible but chemically pure drugs are not necessary.

For mixing on a small scale, round brass wire

sieves are the best. For lances and the more particular work #22 to #26 mesh may be used while for plain mixing #16 to #18 mesh is suitable. If 25 lbs. or more of composition is to be mixed ordinary painted wash tubs are most convenient and the sieves should be made so as to just fit inside the upper edge of same while for mixings of from 100 lbs. up troughs are often used. For these the sieves are made square and fit just inside the troughs, same as with tubs. Mixing machines are sometimes used for bright work or mixings containing no chlorate of potash but they are too dangerous for colors.

With the plain mixings, the coal is weighed first and put into the bottom of the tub; then the sieve put in place and the sulphur, saltpeter etc. pushed through it. When everything is sifted, bare the arms and mix well in every direction. Place the sieve on another empty tub of same size and sift from the first tub into the second one, a scoopful at a time. When all has passed through for the second time repeat once more in the first tub, mixing between siftings and after last sifting. For ordinary compositions this is sufficient but some mixtures are passed four or five times through the sieves.

In colored mixings more care must be observed and each ingredient sifted separately the first time, except the shellac, coal etc., which can be put right into the bottom of the tub. Never throw the chlorate of potass on the sieve at the same time with dextrine or other

hydrocarbon but sift the potass first and add other salts one by one. Great care should be taken never to let the fingernails strike the sieve while sifting as it is very easy to "strike fire" from such causes, with disastrous effect as sharp star compositions in a loose state are almost as explosive as meal powder. Special mixings will be described when we come to the compositions requiring them.

### CASE ROLLING

This is the next most important operation of the business and the one requiring probably the most mechanical skill judging from the time required to learn it and the comparatively small number of really good case rollers to be found in most factories.

All kinds of fireworks require a case of some kind except tableau fires. A good case must be tightly rolled and almost as hard as iron. The best arrangement for case rolling is a sort of large desk made of tongue and grooved flooring tightly joined and firmly nailed to sills of about 2 inches thickness and tapering from 2 inches in front to 6 to 7 inches in the back so as to form a gentle rise from front to rear.

According to the work to be done the rolling board may be made from two to four feet wide. A marble slab also is good for rolling rocket cases.

See FIG. 1      PLATE I.

Most cases are rolled from strawboard, featheredged. The best is made in Elbridge, N. Y. and comes in sheets 26" x 38" with weights varying from 40 to 150 sheets to a bundle of 50 lbs. For rockets, two or three turns of hardware or cartridge paper are used first, backed up by five or six turns of strawboard. The cartridge paper being waterproof swells and contracts but little in rolling while the strawboard, being absorbent swells considerably, therefore when the strawboard is rolled on the outside of the case, it contracts in drying and is shrunk on making a very firm case. Heavy manilla and so called cotton sampling paper also make good rocket cases if carefully rolled but as these shrink considerably in drying, the ramming tools are liable to stick unless specially adapted to this kind of paper. The recently produced "Kraft" paper should make an excellent case though I have never used it. There is also a greyish rag paper which is extensively used for candles.

The best strawboards and pulp boards cost about \$25.00 per ton.

The lightest cases used in fireworks making are lance cases. Some pyrotechnists use poster paper of different colors, corresponding to the color of the composition to be rammed into them while others use linen paper.

Colored paper has the advantage of making lances easily distinguishable in case the boxes containing them become mixed. On the other hand it requires keeping a larger stock of empty cases continually on hand which is sometimes inconvenient. Linen paper is much stronger and only one kind is required, the different colors of lances being kept separ-



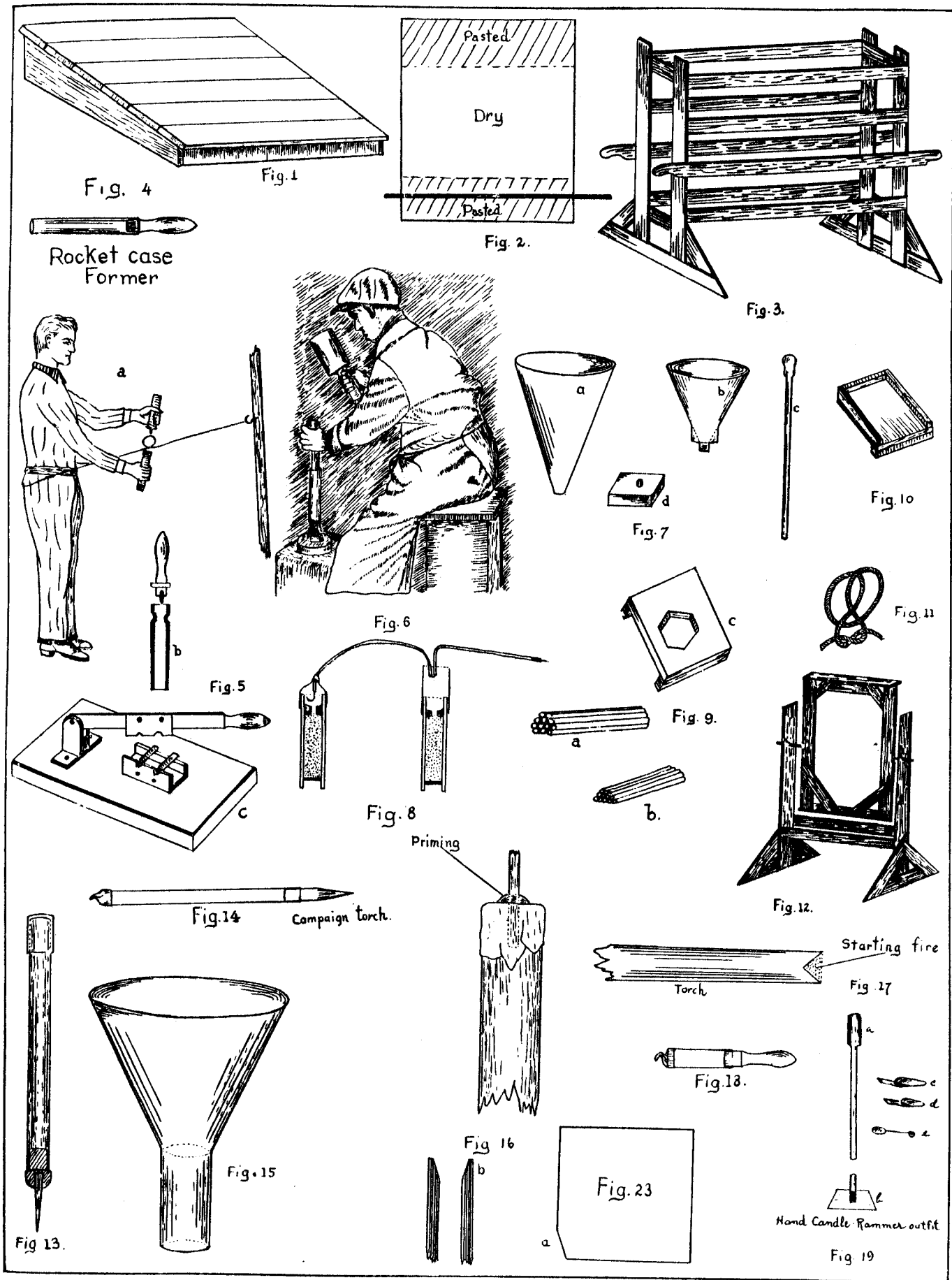

PLATE I



ated by having boxes for them with the colors marked on the outside.

Lances are made from  $\frac{1}{4}$ " to  $\frac{3}{8}$ " in diameter and from  $2\frac{1}{2}$ " to 4" long. Generally speaking, the greater the diameter, the less need be the length. I generally use a lance  $\frac{1}{4}$ " diam. made of ribbed linen paper 17" x 22" about 16 lbs. to the ream, cut in four, the smallest way or across the ribs and six times the long way or with the ribs. This makes 24 cuts from each sheet  $3\text{-}\frac{5}{8}$ " x  $4\frac{1}{4}$ ". Now procure a brass or copper tube with an outside diameter of  $\frac{1}{4}$ " and some good paste. Take a little bunch of say one or two dozen sheets and lay them squarely before you on the rolling board and holding them down tightly with the left hand, rub them gently toward you with the thumb nail of the right hand so that each one will slide about  $\frac{1}{4}$ " below and to the left of the one under it. Apply paste to these edges, lay the tube now on the top sheet about  $\frac{5}{8}$ " from the bottom of same and  $\frac{1}{8}$ " from left or pasted edge. With the ends of the fingers of the right hand bend the lower edge around the tube, laying over about  $\frac{1}{4}$ " and roll to upper pasted end. Then with a turn of the fingers twist the bottom in. The bottoms should not be made too solid and if even a little hole is left in them it will be easier afterwards to stick them on the pins. Sometimes when an exhibition is made on the grounds and not subject to much handling, they are made without any bottoms. They may now be thrown lightly in a basket or sieve to dry. These operations while very simple are quite hard to describe and a few moments of practical demonstration in matters of mechanical detail will go farther than several pages of description.

Pin Wheel cases and Match Pipes are rolled in a general way the same as lances, except that no bottoms are made to them and brass or steel rods are used instead of tubes. The most convenient size for match pipes is one yard in length and  $\frac{1}{4}$ " Diam. Use a good quality of manilla or kraft paper 24" x 36", 20 lb. to ream. The quire is cut the longest way of the sheet, into strips 4" to 5" wide, A steel rod four feet long is the best for rolling them. Pin Wheel pipes are usually made 12" long and  $\frac{3}{16}$ " Diam. Sometimes one end is made slightly funnel shaped by pasting a strip of paper 6" long and 2" wide at one end tapering to  $\frac{1}{8}$ " at the other, rolled around the end of the rod. Rolling match pipes properly is one of the most difficult operations to master, in the business. It is therefore advisable to begin on shorter pipes until practice is acquired.

#### ROMAN CANDLE CASES

These are also somewhat difficult to roll. It is almost essential to have feather edged boards for this work and preferably strawboard. The sheets for one to four ball candles are pasted entirely over with rather thin paste. From six ball up, only about 4" on each end of the sheet should be pasted but on both sides. The manner of proceeding is to lay a sheet on the rolling board, pretty well up near the top, and upside down. Then with a 4" flat paint brush apply paste quite heavily on about 4" of the top of the sheet and about the same amount on the bottom. Now place another sheet on top of this but about one inch lower down, so that an inch

of the first one extends beyond the next on top of it. Paste as before and repeat the operation until a dozen or more sheets are in the pile. Now reverse the entire lot at once so that the former bottom one will be on top. Paste over the bottom and top edges of pile now exposed and rub off surplus paste with a scrape of the rod and you are ready to begin rolling. ( FIGURE 2. PLATE I )

Lay the rod across the pile about 3" from the bottom, lift bottom edge of first sheet, lay it over rod, draw rod with paper around it back, until edge of strip is on top of rod and by sliding the fingers along the rod and edge of sheet until same sticks firmly to it, for its entire length. Now roll firmly along, one hand following the other until the whole sheet is rolled up, care being taken that the case does not run to one side. By a quick backward twist of the rod it is now removed from the former and placed on rack for drying.

The diameter and lengths of roman candles has been changed and reduced so often of late years that no standard of sizes can be given but the following will be found to be as useful as any for the average work and may be used comparatively. Special sizes may be easily adapted to the required circumstances. When cutting paper for candles and other cases as well care should be taken to always cut so the case rolls with the grain of the paper and with the feather edge at the top of the sheet.

<u>No.</u>	<u>Length</u>	<u>Bore</u>	<u>Size of sheet.</u>	<u>No. of strawboard</u>	
1	ball	4 $\frac{1}{8}$ "	5/16"	4 $\frac{1}{2}$ x 6"	140
2	"	5 $\frac{1}{8}$ "	"	5 $\frac{1}{2}$ " x 7"	"
3	"	6 $\frac{1}{8}$ "	"	6 $\frac{1}{2}$ " x 8"	"
4	"	8 $\frac{1}{8}$ "	"	8 $\frac{1}{2}$ " x 10"	"
6	"	12"	3/8"	12" x 13"	"
8	"	15"	"	15" x 16"	"
10	"	17"	7/16"	17" x 20"	"
12	"	19"	"	19" x 20"	"
15	"	22"	1/2"	22" x 26"	120
20	"	26"	"	26" x 26"	"
25	"	32"	"	32" x 26"	100
30	"	36"	"	36" x 26"	"

Cases for rockets, gerbs, fountains, tourbillions, saxons etc., and the small paper guns used for mines, floral shells etc., require considerable skill and strength for rolling, especially the larger sizes. After seeing a great many case rollers at work and employing at different times their various methods, I have come to the conclusion that the following is not only the easiest but makes the best case.

Procure a small hair scrubbing brush of good quality and long stiff hair. Have the paste somewhat stiffer than for candles. Lay the sheet of strawboard on the rolling board, ( in the case of rockets, with the sheet of cartridge paper on top of it. ) Now, with the scrubbing brush rub some paste evenly over the cartridge paper, (not as much as for candles) and immediately roll up as tightly as possible, except the last two inches or so. Now paste the sheet of

strawboard over as you did the cartridge paper and place the partly rolled case on top of it about 2" or 3" from the end nearest to you, seeing that the edges of both are even. Raise the end of the strawboard projecting behind the already partly rolled case and bend it around so it will lay between the part of the cartridge paper left unrolled, and continue rolling, pressing meanwhile, the case firmly to the rolling board or marble slab until the case is completed. This leaves a case that is already half dry and when completely so, should be firm enough that it cannot be bent in on the ends with the fingers. The advantages of this method of rolling heavy cases is that the paper, especially the strawboard has not the time to become softened and swelled up as when a number are pasted down at once, and a tighter, cleaner and more easily and quickly dried case results. If too much paste is used, when the case dries, the water from the paste evaporates, leaving the case spongy.

The sizes of rockets vary as much as those of candles, consequently the following list can only be used approximately.

<u>SIZE</u>	<u>LENGTH</u>	<u>BORE</u>	<u>LENGTH SHEET STRAWBOARD</u>	<u>NO. STW. BD</u>	<u>HDW. PAPER</u>
1 oz.	3 $\frac{1}{2}$ "	3/8"	10 "	140	
2 "	4"	"	13 "	"	
3 "	4 $\frac{1}{2}$ "	"	17 $\frac{1}{2}$ "	"	
4 "	5"	1/2"	20"	120	
6 "	6"	9/16"	13"	"	12"
8 "	7"	5/8"	18"	"	12"
1 lb.	8"	3/4"	20"	"	17"
2 "	9"	7/8"	26"	140	25"
3 "	10"	1"	26"	120	25"
4 "	11"	1 $\frac{1}{4}$ "	26"	120	50"
6 "	13"	1 $\frac{3}{8}$ "	52"*	120	50"*

\* These can be conveniently used in two lengths.

<u>NO.</u>	<u>HEIGHT.</u>	<u>DIAMETER</u>	<u>NO. STRAWBOARD</u>	<u>NO. PIECES</u>
1	4"	1 $\frac{1}{2}$ "	140	1
2	4 $\frac{3}{4}$ "	1-11/16"	120	1
3	5 $\frac{1}{2}$ "	2- 1/16"	100	1
4	7"	2 $\frac{1}{4}$ "	100	2
5	8 $\frac{1}{2}$ "	2-3/8"	100	3
6	10"	2-7/8"	100	4

FLORAL SHELL GUNS

1	9"	2-5/16"	100	3
2	11"	2-11/16"	100	4
3	13"	3-3/16"	100	4
4	15"	3 $\frac{1}{2}$ "	100	5

G E R B S

<u>LENGTH</u>	<u>DIAMETER</u>
9"	3/4"
11"	1"
13"	1 $\frac{1}{4}$ "
15"	1 $\frac{1}{2}$ "
15" Niagara Falls	2"

SHELL CASES

These, though not being rolled (except the canister shell cases) properly come under this division as they are part of the case rollers' business, to make and are composed of paper and paste.

There are two ways of making them. One, roughly speaking, consists of papering the inside of a hole; the other, papering the outside of a ball. We will take a six inch diameter shell as an example to work on as it is the most popular size and the same method is employed for all. First procure a perfectly round ball of wood or some other substance, 5 inches in diam. We then cut strips of strawboard and tag board or heavy paper of most any kind, about  $\frac{5}{8}$ " wide and 4 $\frac{1}{2}$ " long and paste them on a board, one on top of another, with so much paste between them that they will not stick together but will become



soft and pulpy. I have used a sort of red building paper sold in rolls, which made a better case than any other kind I ever used. The strawboard and other paper should not be pasted in the same pile but two piles made, one pile of each kind.

x

Now smear the ball or mold well with paste so it will be wet enough to keep the paper from drying and sticking to it before shell case can be finished. Then take strips of paper from either pile first and lay them on the mold, beginning on top and running half way down the side. Lay the second strip so it will lap over the first one about  $\frac{1}{4}$ " at the lower end and almost over it on top but  $\frac{1}{2}$ " lower down. The third strip should start still a half inch further down from the top while the fourth strip again starts at the top. This will prevent the shell case from becoming egg shaped. Continue this until the entire upper half of the ball has been covered with paper. Each strip must be firmly pressed down and all surplus paste squeezed out with the fingers. Now repeat the operation as before but using the other paper. The object is to make it easier to see where one layer has begun and the other ended as each layer is put on. Another way is to cut the strips a foot long and after softening with paste as above, lay them on the mold from the top to the middle, tearing off the strip at the required point and letting second and third pieces start half an inch below the other so as not to get the top too thick as explained above.

After the third layer has been put on one should be laid on crosswise, crossing as much as possible the first

layers. This process is continued, pressing each strip as firmly as possible until the case is about  $3/8$ " thick at the edges where it is usually thinnest, and not over  $5/8$ " on top. If the work has been properly done the half shell can now be slipped off and allowed to dry. When dry the lower edge should be trimmed off with a sharp knife at a point that will make two halves, when put together show a fair sphere.

The other method is to have a wooden block hollowed out so as to have a hole in it  $5\frac{1}{2}$ " in diameter and a perfect semisphere. Or a mold may be made by taking a ball of this diameter, oiling it well and setting it halfway of its diameter into a box of wet plaster of paris. Now then, proceed as before, except pasting the strips inside the hollow instead of on the outside of the ball. This will make a better looking shell and I believe, a stronger one when properly done. The paper may be cut into strips a foot or more long and torn off as they reach the edge of the hollow. In this way all waste is avoided and the rough edge made more even and regular. The strips should be pressed very firmly as the quality of the shell depends on this. If the pressure against the fingers, in rubbing out the paste, makes them sore, a piece of wood about 3" long and  $1\frac{1}{2}$ " wide, rounded and slightly curved on the edge, may be used as a sort of squeezer. If the work has been well done, the case should be as firm as wood when dried. To assist in removing the wet shell case from the mold, first place in the bottom of it two strips of cloth at right angles with the ends protruding over the sides, long enough to permit pulling the case out by them when it is completed.

In addition to these methods very good shells can be easily and quickly made where hollow balls of zinc, tin or wood can be obtained. The wood half balls need only to be well glued together and they are ready for use. Those of zinc and tin require to be papered just as directed for shell making with round mold except that entire ball is papered until it is about  $\frac{1}{4}$ " inch thick for 6" shell and  $\frac{1}{2}$ " for 10" shells. Others in proportion.

The cases for cylindrical or canister shells need no detailed description as they are made just like any other heavy case. A former of the required size is procured and the case rolled thereon just as for a mine, of strawboard or other paper. When thoroughly dry the wooden heads or plugs are fitted, nailed in with 1 " iron brads, or well glued if made with a flange and carefully sealed all around with several thicknesses of good manilla paper.

#### DRYING CASES

For all cases more than 6" long, racks are most convenient for drying them. These are made of strips of  $\frac{7}{8}$ " x 2" cypress or other light wood, suitable for supporting them. The longer the cases, the farther apart the strips should be. When filled with cases they should be moved to a well ventilated room or covered platform. If placed in the sun they will be badly warped when dry. (FIGURE 3, PLATE I) Center and end strips are  $\frac{7}{8}$ " x 3".

Small cases may be thrown into sieves 2 feet wide by 4 feet long, made of 1 " material, 4" deep and the bottoms covered with hardware cloth of  $\frac{1}{2}$ " mesh.

When cases are stored away care should be taken to protect them from roaches and mice as these are attracted by the paste.

### FORMERS

All paper cases are rolled on formers of one kind or another. For rockets, gerbs etc., these may consist of hard wood sticks but better formers are made of light brass tubing with an outside diameter equal to the diameter of the case desired. They should be one to two inches longer than the intended case and fitted with wooden handles to enable them to be easily removed when case is rolled. (FIGURE 4, PLATE I)

Mines etc., are rolled on wooden rollers, the end of which is turned down to a convenient size to fit the hand. Roman candles are rolled on rods of machine steel while match pipes and pin wheels are rolled on thin brass or steel rods. Lances on small brass tubing.

### PASTE

Without this simple article, I doubt if any great amount of modern fireworks could be produced, as it is in almost constant demand in every department of the factory.

Many ways of making as well as a number of preparations for preserving paste have been given. However, the one I am about to describe, I think, not only the best and simplest but requires nothing for preserving and if properly made, will keep for a month in winter. The process consists mainly in allowing the batter to sour before cooking; and cooking by adding boiling water instead of placing directly on the fire

where it is likely to get lumpy or overcooked. The following details are for making paste in lots of three or four buckets per day.

Procure two deep wooden tubs of about 20 gallons capacity. Buy a barrel of the cheapest grade of flour you can get. Samples or sour and wormy flour will do if it is not adulterated. Put 2 or 3 bucketsful of flour into one of the tubs and add water, stirring meanwhile with a paddle until well mixed and about as thick as is convenient to handle. It does not matter if it is lumpy as these all come out in the souring. When the tub has been filled not more than one third full allow it to rest in a warm place (about 90° F) for two or three days by which time fermentation will have set in. When the fermentation is complete the flour will have settled as a heavy batter in the bottom of the tub with a sour brownish liquid over it. Pour this off and fill several buckets about one third full of this batter. Now have a water boiler of about ten gallons capacity with faucet in bottom, on a gasoline stove or furnace and when this is filled with boiling water place one of the buckets of batter under the faucet. Open it and while the water is running in stir it briskly. The contents of the bucket will at first become as thin as milk but as it begins to fill it will gradually thicken until it can hardly be stirred if all the details have been correctly followed, and a bucket of clear, clean and very sticky paste, free from all lumps will be the result. The other tub may be used alternately with the first for souring batter while that in the first is being used for paste making. This paste, having been soured before cooking cannot sour again

and will not become watery.

Glue and dextrine are sometimes added to make paste bind better and alum, bluestone, salicylic acid etc., to preserve it but these are all unnecessary if made as above.

### CRIMPING

Sometimes gerbs etc. are choked or crimped to reduce the opening, in place of using clay. This is done by taking a turn of strong string or piano wire around the case while still wet, about 3/4" from the end and drawing tightly while turning the case slightly so as to make a neat job. One end of the string should be tied to a wall or some unyielding object while the other is passed around the body.

(FIGURE 5, PLATE I) (a) A nipple with a short point slightly smaller than the desired opening to be left in the end of the case, should be inserted about 1/2" before drawing the string so that the end of the case will be kept open and crimping neatly done (b) A mechanical device made by a Cincinnati machine works does the work very neatly and much quicker than the string process.

### RAMMING

As this operation will be described in detail under each of the articles to be rammed as we come to them, only a few general directions will be given. All ramming should be done in small sheds as far removed from the balance of the factory as practicable and with one side open toward which the operator should always have his back while at work. A stout wood block, either resting on the ground or over a foun-

dation should be used for ramming on. For heavy ramming the best mallets are those made of raw-hide. These are round and run in weight from  $\frac{1}{2}$  lb. to 10 pounds. About 2 lbs. is a good weight for the average work. (FIGURE 6, PLATE I.)

Ramming tools should be made of brass or gun metal; also the nipples while the spindles for rockets must be made of steel.

Scoops for taking up the desired amount of composition at a time, can be made of tin or any light metal and should be provided in different sizes from about  $\frac{1}{2}$ " in diam. and 1" long to 1" diam and 3" long, with about six intermediate sizes as some compositions work better when rammed in small quantities than others with the same caliber of cases.

#### RAMMING WITH ROD AND FUNNEL

For all small work such as serpents, saucissons etc., make a funnel about 4" high, 3" diam. on top and  $\frac{5}{16}$ " at the bottom, without a spout (FIGURE 7, PLATE I.) (a) Procure a rod  $\frac{1}{4}$ " diam. and 12" to 18" long according to work to be done. A wooden knob may be fastened to top of same for convenience in ramming (c). In use, a case is slipped on a nipple (d). The funnel, half full of composition has its small end inserted in top of case and with the rod moved up and down, striking the bottom firmly each time, the composition becomes rammed with sufficient solidity. When case has been rammed to within  $\frac{1}{2}$ " of top, funnel is removed and a charge of clay is added to stop end, by striking clay a few blows with a light mallet and suitable drift or rammer. The arrangement for lances is somewhat lighter. The funnel b is

very efficient. It is 2-1/2" diam. on top and 2-1/2" high with a 3/4" shoulder on bottom and a spout 1/4" outside diameter projecting from bottom for 1/4". This, when removed from lance leaves just the proper amount of case empty for priming.

### M A T C H I N G

This is the term used to designate that function of pyrotechny which consists in bringing fire to the various devices as they are burned. In most of the individual articles a short piece of match is twisted in the nosing of the wrapper or fastened otherwise. In set pieces this operation takes on an importance second to none in the art.

Starting at a leader at which a set piece is lighted and which must be long enough to reach from the device when erected, to a convenient distance from the ground so the operator can reach it the match must lead to every part of the piece.

The matching of lance work is fully described under that heading. In the case of set pieces consisting of gerbs, wheels, etc., the gerb is first primed by smearing a little priming on inside of choked end of case. A nosing is put on, consisting of 2 or 3 turns of stout paper rolled around end of case so as to project 2 inches beyond end. About half an inch of the piping is removed from a length of quick-match. This is bent back, inserted into the nosing and secured by tying tightly with two half hitches. The match is now brought over to the next gerb and bent at right angles over it. At 2 inches from this point it is bent back again onto itself,



and at point of first bend, again at right angles so as to lead to the next gerb. (FIGURE 8, PLATE I) At the bottom of this bend the piping is cut off, bearing match with a sharp knife and this portion pushed into nosing of second gerb and secured by tying as before. Candles, wheel cases etc. are treated in the same manner.

If a gerb has been properly primed it is not necessary for the match to enter choke as fire will reach it from priming.

It is a good plan to have the leader from which a piece of fireworks is ignited, to run to each section of same, irrespective of the fact that said sections are already connected to one another in the process of matching it, as sometimes a length of match will go out in the center of the pipe, owing to some defect not observed in making it. It is therefore advisable to have the match joined wherever it crosses, as for instance, on top of a lance, guarding as much as possible against all chance for one or the other section to fail.

If it is desired to have one part of a piece to go off after the other has been burning a while, as when candles or gerbs are used in connection with lance work, these gerbs etc., are matched to a separate leader which may be fired by hand after the lances are half consumed, or they may be connected to several lances about half way down so that when they have burned to this point the balance will be lighted automatically. This is done because, lances burning so much longer than candles or gerbs, if all are fired at once, the gerbs etc would be finished before the lances were well under way, while

it is best for the finest effect to come at the end.

### P R I M I N G

In order to insure lighting, especially in exhibition work, all gerbs, wheel cases, lances etc., are primed which consists of smearing a little moist gunpowder about the mouth of the case. Priming is made by adding water to grain powder in a suitable receptacle until the powder becomes pasty. A little alcohol and dextrine can be advantageously added.

### FINISHING

In factories, where stock or shelf goods are made this is quite an important department. All kinds of fireworks are covered with some kind of colored paper and often stripes and borders are added. Candles, rockets serpents, small mines and triangles are covered with different colored paper. Flower Pots are usually covered with calico paper while fancy rockets, large mines saucissons, floral shells and fountains are covered with glazed paper, stripes being added where desired. The size of cuts as given here are for use with candles and rockets of the size shown in this work. They are usually 2" longer than the article to be papered if it has to be matched at one end and tucked in at the other; 1" longer where matching only is done and the same length where only the case is covered as in mines etc

1	ball	Roman	Candles	2" x 6"
2	"	"	"	2" x 7"
3	"	"	"	3" x 8"
4	"	"	"	3" x 10"
6	"	"	"	4" x 14-1/2"
8	"	"	"	4" x 17"
10	"	"	"	5" x 19"

12	Ball Roman Candles	5" x 21"
15	" " "	6" x 24"
20	" " "	6" x 28"
25	" " "	6" x 34"
30	" " "	6" x 38"
1 Oz.	Sky Rockets	3" x 5"
2	" " "	3" x 6"
3	" " "	4" x 6-1/2"
4	" " " with cone	4" x 6-1/2"
6	" " "	5" x 7"
8	" " "	6" x 8-1/2"
1 lb.	" " "	6" x 9-1/2"
2 lb.	" " "	7" x 10-1/2"

### WRAPPING

To make a good neat, tight and strong bundle is about as important and I may say difficult to learn as any other part of the fireworks business.

Roman Candles from 1 to 4 ball are packed 3 dozen in a bundle. From 6 ball up, one dozen in a package. The packages of one dozen are made of two forms, viz: four sided and six sided. (FIGURE 9, PLATE I.) b and a respectively.

To make the four sided package of 1 dozen. 8 ball candles lay five on the bench in front of you so that the candles run parallel with the bench. Mark the space they cover and fit into top of bench four wood pins about one inch of which project above, two on each long side of the space occupied by the 5 candles, so same may be easily laid between them. See dots, FIGURE 9.(b) Now cut a sheet of manilla paper 19" long and 14" wide and lay this between the pins just as the candles laid before, and replace the five candles, now on top of the paper between the pins. On top of these five place four more and on top of them three. This makes twelve. Draw the paper tightly over them and fold it like a druggist makes a bundle. Now close the ends as follows: with two

fingers press the top of the folded paper over the end of three top candles; then, holding same down with both thumbs, fold in the two sides of package with the first and second fingers of each hand at the same time; then holding these folds with the left hand, lift the opposite end of the bundle with the right which will cause the bottom to fold itself over the other folds. Now, with the brush dipped in thick paste give the end a daub on the last fold and while the bundle is still standing on this end fold the top end the same way. Before folding the last fold give it a daub of paste as you did the other end. Lean against the wall and place a paper weight or tile on top of end to hold it in place until dry. After a quantity are packed like this and dried the labels are affixed.

To make the six sided bundle a person must first learn to form the candles in the hand. Count out one dozen candles and encircle the bunch at one end with both hands. Now work them about (this is hard to describe on paper) until they form a triangular bunch (a) with three candles on each side of the triangle. When this has been accomplished, lay them on the wrapping sheet ( cut as described above, though preferably wider) holding them lightly so they retain the triangular form. To get the paper around them without having them fall in a heap is still harder to describe and equally hard to master though easy enough when learned. Once the bundle has been gotten to the wrapping sheet one hand is sufficient to maintain its form so with the other lift the side of the sheet nearest you and bend it partly around the package

so you can hold it while the other hand is released long enough to enable it to take the paper on that side. Straighten and flatten it well on over the candles and begin rolling up the bundle until the other edge of the paper is reached. Paste this edge and lap it on the bundle and you are ready for the corners. If the bundle has been properly made, when it lays on one of the faces of the triangle, the top row must be composed of 2 candles; the second row 3, the third row 4 and the bottom row 3. Now bend the paper down from the top first, then bend in the two upper sides, then the two lower sides and finally, by lifting the bundle, from opposite end, the bottom folds over all the others. A little paste secures it as described above.

The bundles of smaller candles are formed in a wooden former, hollowed out to the size of a bundle of 3 dozen (c) and when it is packed with the required number they are secured with a string preparatory to wrapping.

Short stick sky rockets are nearly always packed in paper boxes., long sticks are packed as follows: Cut some pieces of #18 iron wire 6 inches long. Then take half or a dozen rockets with the heads all even and work them in the hands until they form as square a bundle as possible and bend one of the pieces of wire around the sticks just below the matches. This should be done with one hand while the other holds the bundle in shape. Now pass another wire around the sticks about a foot from the bottom. Cut some pieces of strawboard as wide as the bundle of rockets on the wide sides and long enough to go completely over the heads and down the other side nearly to the matches. Cut some wrapping

paper six inches wider than the rocket head bunch and long enough to go twice around it. Paste the far edge for about 1 inch and lay the bundle of rockets with the strawboard around it, on the sheet and wrap it up as tightly as possible. Fold in the upper end; secure with a little paste and set aside, heads downward, to dry. Later, the other end may be gathered in and secured with another piece of wire.

Wheels, tourbillions etc. are made into most any kind of a package desired, while mines, fountains etc. are given one or two turns of paper over the finishing to keep them clean.

Serpents, flower pots and torches are packed like roman candles. Blue lights, the same. Fancy rockets are packed heads and sticks separately, the heads in boxes and the sticks loose.

### W I R I N G

For most purposes annealed iron wire from 18 ga. to 20 ga. is the most serviceable. The easiest and quickest way to use it for wiring rockets, triangles, etc., is to cut it in lengths of from 4" to 6" according to the size of the work to be done. A large quantity can be cut at once by using a bench shear and cutting several hundred at one time. Rockets can be quite securely fastened with one wire if a GUM BOARD Figure 10 is used. Else two wires are necessary. A gum board is made by taking a piece of  $\frac{1}{2}$ " board 6" long and nailing pieces of rocket stick around it on three sides on top and one side on the bottom. Put into this about 1 oz. of dextrine mixed with water to the consistency of jelly and and it is ready to commence wiring. (FIGURE 10. PLATE I)

Put a pile of rockets and wire to your left and a bundle of sticks and the gum board to your right. Rub one side of the end of a stick against the bottom of the gum board so a little gum will adhere to it. Lay it with the gummed side against the rocket about three quarters of the way to the cone. Hold it in this way in the left hand and with the right, bend a wire around it about the middle giving one turn on the side of stick. Now, with a pair of nippers give about three more turns cutting the wire with the last turn. If no gum is used two wires are necessary.

### T Y I N G

In doing exhibition work string plays a very important part and the best and most convenient knot for all purposes is the sailors two half hitches, (FIGURE 11, PLATE I ) This is somewhat difficult for most persons to learn. The best way is to practice on a stick. Pass string under stick bringing free end over left of loop; Bring it over same again passing end again to left of second loop but between second and first. An ordinary tie of the free ends now secures it permanently. This knot will be found invaluable in matching.

### LABELLING

This very easy operation may be still further simplified if done in the right way. Take a board about a foot square. Smear it well on top with thin paste and lay a label on it, face down. Cover this well with paste and place another label on top of it repeating the pasting and putting down of labels until several dozen are on the board. This

will soften them so that when taken up and pressed with the fingers or the paste brush against the bundle to be labeled they will adhere firmly and lay flat.

### DESIGNING

When it is desired to produce in fireworks a portrait, a picture of a building, monument etc. or a line of lettering this is first drawn on the floor with a piece of chalk fixed into the end of a stick so that the designer may walk about sketching his picture from the miniature plan as he goes along. The floor is first laid off with a chalk line into squares one foot each way and in multiples of 50 sq. ft. five feet wide and 10 feet long. For instance, if a picture 10' high and 20 ft. long is desired it is composed of 4 sections 5' x 10' or two high and two wide.

The sketch is now taken and marked off with rule and dividers into 200 equal squares, 10 high and 20 wide corresponding to the full sized squares on the floor, These are numbered along the edge of sketch on top and on one side. The squares on the floor are numbered in the same way. With the chalk now draw into each square on the floor, the same lines as appear in corresponding square of sketch. When this is done, an exact reproduction of small picture will be ready to be placed on frames.

For lettering or lines of wording this is not necessary as design can usually be drawn directly onto the floor with free hand, of the desired size and without enlargement. (SEE FIGURE 57 PLATE IV. )



P A R T      III

ARTICLES OF MANUFACTURE

AND RECIPES

M A T C H

As almost every piece of fireworks requires match for lighting it and lance work and exhibition pieces in general are absolutely dependent on good match for their successful operation, it is most essential to make this very necessary article as nearly perfect as possible. There are several ways of making match, which I will classify as the "French System" and the "English System" and candle and rocket match, and describe them in this order.

F R E N C H   S Y S T E M

Secure a long dry shed, say 30 to 40 feet long and set up a piece of 1" x 3" lumber about 3 feet long, with 10 penny nails driven half way into one edge about  $1\frac{1}{2}$ " apart, at each end of shed and about 3 ft. above the floor, parallel with same, and securely fastened so they cannot pull away. Then take about 2 dozen balls of good cotton wrapping cord such as is used for tying bundles. Put from 4 to 7 of these according to the thickness of match desired, into a small light box, having previously loosened the ends of the balls for about a foot. Tie all the ends together and fasten the bunch to the first nail nearest the wall and farthest from you, and holding the box containing the balls of cord in your left hand with the bunch of loose ends passing through your right hand, walk toward the other end of the building where you have the other nailed strip and tie the bunch of strings by a few turns around the corresponding nail on same.

Now take 3 lbs. of rifle powder and mix it well with 3 ozs. of dextrine. Then add water and stir well with the

fingers until all the grains are wet. Allow to stand a few minutes (until a small lump pressed between the fingers feels perfectly smooth and contains no more grains) when more water or better still, alcohol is added until it is about the consistency of porridge or a little thicker. This should be prepared in a small metal wash basin. Holding the basin with the left hand, under the first length of the bunched cord take up a handful of the wet powder and work it well into the cord, holding the basin so as to catch the drippings and walk backwards toward the other end of the cord. When this is reached and the cord well covered take hold of it lightly with the thumb and first finger allowing it to pass over second joint of forefinger and go over the strand again but without working in any more powder unless bare spots are found. This is more to mold off the rough places left the first time. When the strand looks smooth and round stretch another from the box of twine balls and proceed as before until all the powder is used up. If the weather is dry the match will be ready for piping in a day or two. If it feels firm and stiff it is dry enough to cut down and the pipes may be threaded on. In piping match crease or gather the end of first pipe when in place, so next one may be slipped over it for about an inch. \*

\* Wicking or cotton cord of the proper thickness can now be secured in one ball.



ENGLISH SYSTEM

Make a light frame of wood like the frame of a looking glass, (FIGURE 12, PLATE I) six feet long and 4 feet wide and hang it in an upright stand so it can revolve just like the mirror in a dresser. Then get a dozen balls of round cotton lamp wicking, 7 to 9 strand. ( See note under "French System") Unwind about six balls, one after the other, tying the end of each to the next, into a tin pan about a foot in diameter and 6" deep. Now, in another similar pan put  $2\frac{1}{2}$  lb. rifle powder mixed with  $2\frac{1}{2}$  ozs. dextrine and cover it with  $2\frac{1}{2}$  pts. water, stirring occasionally until powder is dissolved. Then add  $2\frac{1}{2}$  ozs. alcohol and mix well. Pour this over the lamp wicking in the first pan taking care to leave the end of wick hanging over edge of pan so it can be easily found. Beginning with this end now run all the wicking into the empty pan, taking care that every part of it is well soaked with wet powder. If there is not enough composition to soak it all thoroughly more must be made, or, if much remains add more cotton. A little should remain after the cotton is passed for the first time and this may now be poured over the pile of wet wick and same should be well pressed or kneaded so as to thoroughly soak every part, when it can be returned to the first pan as before. It is now ready for the frame. Tie the end of the wick to one side of end of frame and while someone turns it slowly feed match onto it with the strands about  $\frac{5}{8}$ " apart. When all of it is on the frame remove from stand to a part of the floor covered by large sheets of paper and support it over these on four blocks about 3" high, one at each corner of frame. Now take a small sieve of meal powder and

dust it carefully over the match so as to cover it evenly with a layer of the powder. The frame may now be placed in the sun or elsewhere to dry.

Match made by this process is all of one length, viz: 2 yards, and is very round in appearance. It burns fiercely but will not stand as severe usage as that previously described. It also takes longer to make.

#### ROCKET AND CANDLE MATCH.

Match made by any of the previous methods is too expensive for the cheap grade of stock fireworks on the market, so a simpler method has been devised for this purpose. It is essentially like the last described process.

Into a small tub put about a gallon of starch, well boiled, and stir into it about 5 lbs. of a thoroughly mixed composition made of

Saltpeter	16
Fine Char-coal	5
Sulphur	2½

Soak in this, cotton wick of about 5 strands until nearly all of the composition is absorbed but about  $\frac{1}{8}$ " should still cover the cotton in the tub. Work it in well and run it onto a frame as directed in preceding description but the frame may be smaller for convenience of handling by one person, as long lengths are not required. Neither does it need to be dusted with meal powder. If well made, however, it will burn freely and serve its purpose completely.

When dry it is tied in bunches, 1 to 2 inches in diam. and cut into the desired lengths with a tobacco cutter or large sharp knife.

TABLEAU FIRE

This is about the simplest form of fireworks at present in use. It is made by mixing thoroughly the necessary ingredients to produce the desired color and heaping it on an iron plate or board in a pile so it may be easily lighted. Or it may be put in tin cans for the trade.

Good tableau fire should burn brightly without sputtering and smoke as little as possible. It should take fire easily but never be liable to spontaneous combustion. Lithographed cans may be used as container, designating by their color the color of fire they contain and with firing directions printed on them. A small piece of match placed in each can facilitates lighting it.

WHITE FIRE.

Salt peter	3	12	8	7
Sulphur	1	2	2	2
Metallic Antimony	1			
Sulphide of antimony	1	1		
Realgar			1	1½

BLUE FIRE

Chlorate of Potash	6	8	8	12
Paris Green	4	6	6	8
Stearine	1	1½	1½	2
Shellac		1½	1½	
Nitrate of Baryta	4	8	7	8
Calomel			1	
Sal ammoniac		1		1½

In order to make tableau fires more bulky, one to two parts of fine saw dust may be mixed with any of the above recipes without materially affecting the color. It should also be borne in mind that paris green is very poisonous and a handkerchief should be tied over the nose if it has to be

handled much.

RED FIRE

Nitrate of Strontia	80	80	10	16	30
Chlorate of Potass.	32	22	4	8	20
Shellac	24			3	1
Sheel-lac or Kouri Gum		12	3		
Asphaltum					
Charcoal			1		
Dextrine		1			
Fine Sawdust		12			
Rosin			1		
Lampblack		1			

If the sawdust will not pass freely through the sieve it may be added after the other ingredients are sifted and mixed and rubbed in with the hands.

PINK FIRE

A fire somewhat cheaper than the above but inferior in color, may be made as follows:

Nitrate of Strontia	48	16	18
Salt peter	12	4	7
Sulphur	5	2	2
Charcoal	4	1	$\frac{1}{2}$
Sheel-lac			
Dextrine		3	$2\frac{1}{2}$

This should not cost over 7¢ per pound while the other formulas cost about 9 $\frac{1}{2}$ ¢ per pound. A pink light may also be made by substituting lime or chalk for strontia but more chlorate of potass is required and the smoke is greater.

GREEN FIRE

Nitrate of Baryta	8	9	4
Chlorate of Potass	4	3	$2\frac{1}{2}$
Shellac		1	$1\frac{1}{2}$
Sheel-lac	2		
Dextrine		$1\frac{1}{16}$	
Fine Saw Dust		$\frac{1}{2}$	
Sal Ammoniac	1		



YELLOW FIRE

Nitrate of Baryta	36
Oxalate of Soda	6
Sulphur	3
Sheel-lac	5

I have never found anything better or as good as this, therefore give only the one recipe.

SMOKELESS TABLEAU FIRE

For theatrical or indoor use colored fires are very objectionable on account of the choking smoke they give off. The following mixings give a fire producing very little smoke which quickly dissipates after fire is burned.

RED

Nitrate of Strontia	8
Picric Acid	5
Charcoal	2
Shellac	1

GREEN

Nitrate of Baryta	4
Picric Acid	2
Charcoal	1

Dissolve picric acid in boiling water; add strontia or baryta; stir until cold and dry on filter or piece of cloth

It should be observed that in all mixings, the formulas cannot be considered absolute as the purity and general characteristics of chemicals differ so much that all mixings must be tested and regulated to the existing conditions of materials, climate etc. If tableau fire burns too slowly more potass. or coal should be added; if too fast, more strontia, baryta etc. In rocket, candle or gerb compositions, salt-

peter or meal powder will increase the combustion while coal and sulphur will retard it,

### T O R C H E S

These may be classified according to the purpose for which they are intended. Military torches have but one requirement which is that they produce the maximum illumination of the deepest hue of color desired. As these are fully described in special works issued by the government and really form no part of commercial pyrotechnics it will be unnecessary to devote further space to them here. Railway torches or fusees, on the other hand, are the cheapest form of pink light, as anything capable of attracting the attention of the engineer is all that is required. They are usually  $\frac{5}{8}$ " diam. and 8" to 12" long exclusive of the handle and burn from 5 to 20 minutes. The following compositions are adequate.

### RAILWAY FUSEES

Strontium Nitrate	48	16	18	16
Saltpeter	12	4	7	4
Sulphur	5	2	2	5
Fine Charcoal	4	1	$\frac{1}{2}$	1
Red Scheel-lac Gum	10	3	$\frac{1}{2}$	
Dextrine			$\frac{1}{2}$	

Fusees are provided with a slip cap which is used for igniting them. The end of the torch is capped with paper onto which is painted a mixture of

Potass Chlorate	6
Antimony sulfid	2
Glue	1

while the end of the cap is similarly painted with a paste of

Amorphous Phosphorus	10
Black Oxid of Manganese	8
Glue	3

When the cap is pulled off and struck against the end of the fusee it takes fire like a safety match. With some compositions it is necessary to have a little starting fire at

top of torch just under the capping or priming under the cap which will suffice to cause easy ignition. (FIGURE 13, PLATE I )

#### PARADE TORCHES

Parade torches, for campaign purposes, where a cheap grade of fire suffices and where competition urges the manufacturers to produce the largest article at the smallest price, one of the methods is to add 50% of fine sawdust to the mixing. This does not greatly affect the burning of the torch and makes it look twice as large at practically no extra cost. The following is a good formula:

Nitrate Strontia	40
Potass, Chlorate	8
Red Scheel-lac Gum	7

Saw dust may be added ad libitum. The torches are usually 3/4" diam. and 12 " long and should burn with the above mixing, 8 to 10 minutes.

#### RAMMING TORCHES

A very cheap method of ramming these torches is to moisten the composition with dilute dextrine solution until it is damp enough to hold together when a handful is tightly squeezed. A dozen torch cases are tied into a bundle and pressed into a pile of damp, composition on a slab. It is then moved to a clear part of the slab and jolted firmly against it by lifting the bundle a few inches and jarring it downwards. More composition is shaken in from the top

when the jarring is repeated and this continued until torches are full when they are set aside to dry. By this manner a dozen torches may be rammed in one minute. The handles may be attached by a strip of gummed paper 2 inches wide, half of which encircles the torch and the other the end of the torch handle. The other end of torch is nosed and matched in the regular way, FIGURE 14.

A better way of ramming torches is as follows:

Tie the cases in bundles of 12. Place on ramming block and insert spout of funnel ( FIGURE 15, PLATE I) into one of them. Then pass a suitable rod through it until it rests on block also. Now, with a scoop, fill the funnel with composition and, steadying same with the left hand, grasp the rod firmly with the right and raising it about six inches, drive it with a firm stroke up and down as the composition runs into the case. Continue this operation until case is filled. When funnel is removed the space occupied by the spout will serve for inserting the handle which is done by applying to it a little gum or glue.

#### TORCHES FOR CARNIVAL PARADES

These present the most exacting requirements and the following formulas are the result of more than 30 years of experimenting during which some exceptional mixings have been developed as well as some most beautiful colors which, in modified form, may be used for box stars in shells etc.

Carnival Parade Torches must be of deep color, give maximum illumination; burn slowly and cleanly, not be prohibitive in cost and give off as little smoke as possible.

They should burn not less than 15 minutes with a length of about 18", exclusive of handle, and a diam. of 7/8".

The standard formula of 40 years ago was:

RED

Strontium Nitrate	16
Potass, Chlorate	8
Shellac,	3

however, this burns somewhat fiercely and is rather expensive.

A better mixing is:

Strontium Nitrate	14
Potass, Chlorate	4
Ground Asphaltum Gum	3

or

Strontium Nitrate	14
Potass Chlorate	4
Red Sheel-lac	7-1/2

This will burn 17 minutes in an 18" torch. The latest formula giving exceptional results is:

Strontium Nitrate	9
Potass, perchlorate	2
Sulphur, ground	2
Red Sheel-lac Gum	1

GREEN PARADE TORCHES

A good formula for 15 minute green is:

Barium Nitrate	40
Potass, Chlorate	11
* K. D. Gum	6
Sal Ammoniac	1

another is:

Barium Nitrate	30
Potass, perchlorate	6
Sulphur ground	3
* K. D. Gum	2

\* K. D. Gum is supplied by New York dealers in pyrotechnical supplies.

BLUE PARADE TORCH

No considerable success has been attained in producing a blue torch but the following recipes are the best available:

Potass, perchlorate	5	24
Paris Green	2	
Copper-Ammon. Sulphate		6
Dextrine	1	
Calomel		9
Sugar of Milk		2
Sulphur		9

A most beautiful

PURPLE PARADE TORCH

HAS lately been worked out as follows:

Strontium Nitrate	7	
Potass, Perchlorate	8	
Blk. Oxid of Copper	4	
Calomel	2-1/2	
Sulphur	7	

An amber torch to match the above for richness of color, slow burning and almost smokeless, is the following:

AMBER PARADE TORCH

Strontium Nitrate	36	
Sodium Oxalate	6	
Shellac	5	
Sulphur	3	
Potass, Per Chlorate	3	ad. lib.

Great care should be observed in mixing compounds containing sodium oxalate, that all the ingredients are perfectly dry and it is best, in a damp climate, to mix only on clear days for the reason that the least moisture is liable to cause the oxalate to decompose forming sodium nitrate or chloride which is still more deliquescent than the oxalate and the work is soon so wet that it will not burn. Even when mixed in dry weather it should be protected from dampness by parafined wrappings or otherwise.

In cutting the paper for a 15 minute parade torch 7/8"

diam and 18 inches long cut 35 to 40 lb. Kraft paper so it will roll with the grain 11-3/4" and across the grain 18" in length. This will give four complete turns and cause more regular burning. Pasting the outer edge for 3 or 4 inches will be sufficient.

#### CAPPING AND MATCHING PARADE TORCHES

A good method of doing this work and used by one of the largest manufacturers in this country, is as follows:

Cut some cotton cloth into pieces about 2 inches square. Cover them with paste and bend them securely over the tops of the torches as shown in sketch (FIGURE 16, PLATE I) When they have dried punch a hole about 1" deep through the cloth and into the top of torch, with an awl about 1/8" diam. Into this insert the match. Then make up some thin priming of gunpowder, gum water and a little alcohol. Place this in a squirt oil can with large opening, and, shaking frequently to prevent it from separating, press out a drop or two at the point where the match enters top of torch. If this is properly done it will secure the match in place and cause the torch to ignite freely.

#### ALUMINUM TORCHES

This beautiful piece of pyrotechny was first introduced in parades by the author, with sensational results. A row of 12 men were placed at the head of the line of march and with these all burning aluminum torches simultaneously there was produced the effect of an oncoming avalanche of fire.

For this torch a case 1/2" diam. and 16" long is used with a round wooden handle 6" long in the lower end. They are

rammed and matched much as other parade torches and a good formula is:

Potass, perchlorate	13
Fine Aluminum Powder	6
Flake Aluminum	5
Dextrine or Lycopodium	1

A beautiful modification of this torch is the

#### RED AND ALUMINUM TORCH

These should be 7/8" diam. 18" long and of the following composition.

Strontium Nitrate	35
Potass, Perchlorate	7
Shellac	4
Coarse Flake Aliminum	4
Lycopodium	1

another formula is:

Strontium Nitrate	4
Shellac	1
Mixed Aluminum	1

Before ramming this should be moistened with a solution of 1 part shellac in 16 parts of alcohol and one part of this solution used to every thirty six parts of composition. As this mixture is somewhat difficult to ignite it is necessary to scoop out a little from the top of the torch and replace it with starting fire made of

Salt peter	6
Flowers Sulphur	4
Fine Charcoal	1

(See FIGURE 17, PLATE I )

An aluminum torch of heretofore unheard of brilliance and giving an illumination, in the 1 inch diameter size, of what is said to be 100,000 candle power is made as follows:



Barium Nitrate	38
Mixed Aluminum	9
Sulphur	2
Vaseline	1

Rub the vaseline into the Barium nitrate; mix sulphur and aluminum separately; then mix with barium nitrate and vaseline, A starting fire for this also is required, as follows:

Barium Nitrate	4
Salt peter	3
Sulphur	1
Shellac	1

#### PORT FIRES

These are small torches 3/8" diam. 12" long, used in exhibitions for lighting other pieces of fireworks. They are rammed with rod and funnel and a good mixing is:

Meal Powder	1
Sulphur	2
Salt peter	5

#### SHIP LIGHTS AND DISTRESS SIGNALS

##### "BENGOLAS"

Another form of torch is the Bengola or Blue Light used mostly by ships in signalling for pilots. They consist of a stout paper case 1-1/2 inches in diam. and 4" long, 3" inches of which is composition and 1/3" clay at bottom; the balance being the socket into which the handle is fitted. (FIGURE 18, PLATE I) They should be rammed quite hard; the nosing should be of good strong paper secured around the match with twine and the match should be piped where it passes through the nosing.

The finished light should then be painted with melted paraffine so as to protect it against the dampness of the sea air. This is an average formula:

Saltpeter	12
Sulphur	2
Antimony Sulfid	1

Distress signals are the same except that they burn red. The regulation Life Boat equipment consists of 6 or 12 enclosed in a water tight copper can. The following formula is suitable.

Potass, Chlorate	5
Strontium Carbonate	1-1/2
Shellac	1
Dextrine	1/2

#### TOY BLUE LIGHTS

These are little lights 1/4" diameter and 6" long made by rolling a light case as for lances. Cut the paper 2" x 6", the 6" way running with the grain of the paper. One end should be closed as for lances. Bunch about 200 into a bundle with string, all the open ends being uppermost when the bundle is stood on end. Now make the following composition:

Saltpeter	5
Sulphur	2
Antimony Sulfid	1

When thoroughly mixed place it on a large sheet of strong paper previously spread on a firm table. Set the bundle of blue light cases alongside of the composition on the paper, with the open ends up and pour a handful of composition on top of them. Shake the bundle so as to make composition fall into the cases as much as possible and repeat several times. Now with both hands raise the bundle of partly filled

lights and bring it down on the table with a good blow. Repeat this several times and then again the first operation of filling them and pounding them on the table until all are well filled when the ends may be tucked in with a dull awl.

### ROMAN CANDLES

These are probably the most popular pieces of fireworks made, from a sales point of view. Up to some years ago they were made entirely by hand, that is, one at a time. Then a combination rammer taking a dozen at a time was devised. And later the Candle Machine which handles six dozen was perfected. To make roman candles by hand, roll the cases as described and have a lot of stars of different colors ready. Then make some candle composition as follows:

#### ROMAN CANDLE COMPOSITION

Powdered Saltpeter	18 lbs.
Fine Powdered Charcoal	11 "
Flowers of Sulphur	6 "
Dextrine	1 "
Water	1 Gallon

After all the ingredients are well mixed and sifted three times add the water and mix again until the whole lot is evenly dampened. Then force through a 16 mesh sieve into cloth bottomed trays and dry in the sun.

Now provide a ramming outfit as shown in FIGURE 19, PLATE I consisting of a pin block (b) a rammer (a), a composition scoop (c) a clay scoop (d) and a gunpowder scoop (e)

The various parts must, of course, be proportioned to the size of candle it is intended to make. Say you will begin with an 8 ball. The pin of pin block must be  $3/8$ " diam. The rammer, slightly smaller so it can pass easily up and

Detail of Shifting Boards.



Fig. 21.

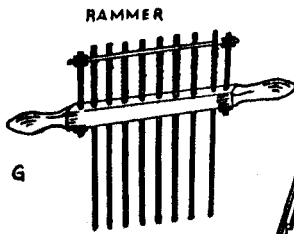
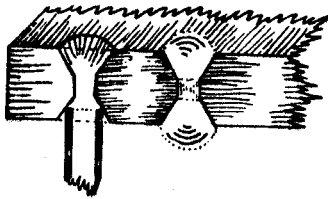
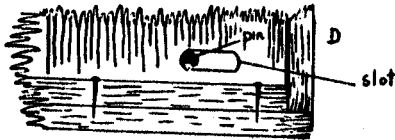

Spring



Detail

Compo. board a

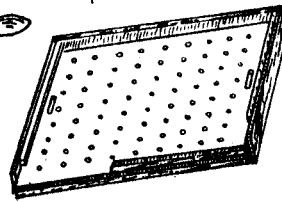

Star board b

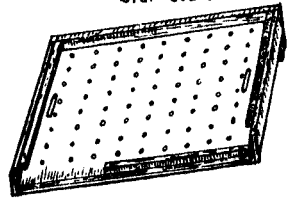
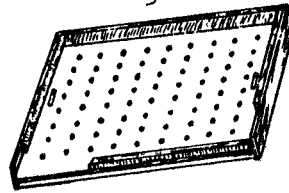
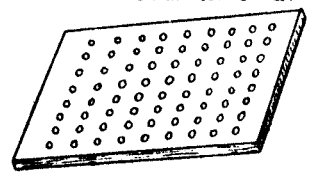

Fig. 20

Clay board c



Guide board d.



Funnel plate f

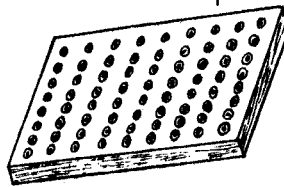

Pin plate e

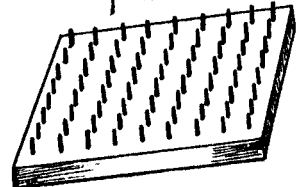

Fig. 23.

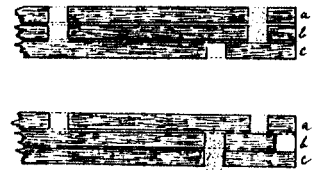
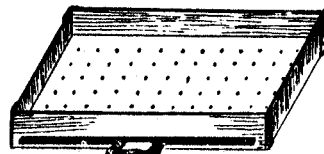

Fig. 24

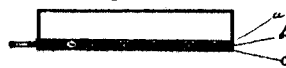

Fig. 22

- 1 Rammer head plate.
- 2 Rammer rod.
- 3 Rammer guide board.
- 4 Brass narrow lip.
- 5 Funnel plate.
- 6 Roman bundle case.
- 7 Lower guide board.
- 8 Pin plate.
- 9 Pin plate.

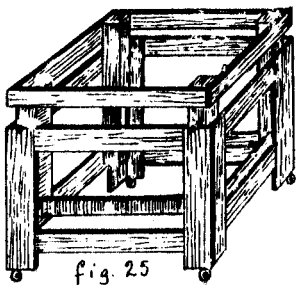

fig. 25

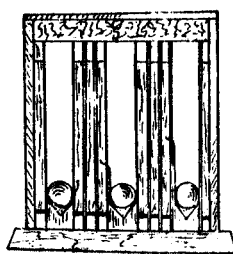

Fig. 27



Fig. 26

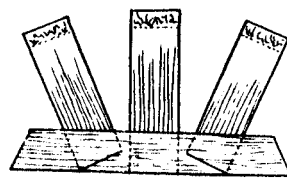

Fig. 28

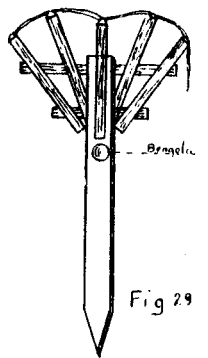

Fig. 29

down the candle case which also is  $3/8$ ". The clay scoop should hold a level teaspoon full of clay; the compo. scoop, a heaping dessert spoonful; and the gunpowder scoop should be  $1/4$ " diam. and  $1/4$ " deep. It may be made from a .22 cal. rifle shell, if desired.

Now place an empty case on the pin; pour in a scoop of clay and ram it firmly with a light mallet. Remove rammer; pour in a scoop of gunpowder on top of which drop a star and lastly, a scoop of candle composition. Ram with about six blows of a light mallet. Remove rammer and pour in another scoop of gunpowder; another star and another scoop of candle composition, repeating this until case is filled to within 2" of the top. Remove candle and finish as described under that head.

#### HAND COMBINATION CANDLE RAMMER

(FIGURE 20-21, PLATE II)

This consists of an iron pin plate (e), funnel plate, iron (f), a wooden guide board (d), three wooden shifting boards, viz: clay board (c), star board (b), and composition board (a) as well as a gun-powder box Figure 24 and rammer (g). The construction of shifting boards can be readily understood from detail sketch FIGURE 20.\* The holes in upper board are of a size to contain just sufficient compo. clay etc. for one charge (A). This board slides a distance of about  $5/8$ " controlled by pin (CD). When upper board is pushed back the holes are filled and when ready to discharge it is drawn forward so the holes are in line with the holes in lower fixed board when the contents falls through funnel plate into candle

\* The pins shown in upper plate should be reversed so that slot is in lower plate. Otherwise it will become clogged with composition while in use.

being rammed, (B). The gunpowder box is described under "Candle Ramming Machine" so it is unnecessary to repeat its construction. It is of course smaller than the one for large machine and made of size to correspond to pin plate etc. Finally there is the rammer (FIGURE 21, PLATE II) (g) consisting of eight steel rods with compression springs fitted through a wooden handle bar as shown, with detail of whole at F.

This apparatus is used for ramming one to four ball candles and can also be used for serpents and saucissons.

Place pin plate on some solid wood block or concrete base; place guide board over pins so that the holes encircle the pins fairly; slip a candle case on each pin; place funnel plate on top of assembly and raise guide board so as to make cases center nicely.

Now, fill clay board, composition board and star board. Place clay board over funnel plate so holes are in line and shift, tapping lightly so that all clay falls out through funnel plate and into candles. With rammer give 10 to 15 strong blows through each row of holes. Put on gunpowder box and draw plate until a charge enters candles. Then take star board; place as was done with clay board and shift. See that all stars have entered candles and put on compo. board. When this has been discharged give about eight to ten blows with the rammer, not quite as hard as for the clay. Now give another charge of gunpowder, another board of stars and a second charge of candle composition (if more than 1 ball candles) and repeat until desired number of stars have been used.

(FIGURE 22, PLATE II)

The ramming machine herewith illustrated was designed in Cincinnati and is used principally for ramming roman candles from 6 ball to 30 ball but up to three ounce rockets may be rammed solid with it and the hollow center of rocket made by driving a spindle into it afterwards as will be explained later. Flower pots may also be rammed with this machine and the writer has adapted it to making 3" cannon crackers at the rate of 72 at a time. However, several sets of rammers of different lengths and thickness are required for the different sizes of candles.

The frame is of cast iron about seven feet high; the upright sides are  $1\frac{1}{4}$ " thick with a V edge on inner sides upon which the head block (A) slides. The rammer assembly is fastened to head block by stud bolts. The guide board (C) is made of  $\frac{1}{8}$ " lumber and serves to keep the rammers properly in line. This board is loose enough to slip up and down on the rammers while machine is in use. The pin plate (d) rests on base of machine and is slid into place from in front and retained by short stops in the rear. Several of these plates also are required, corresponding with the rammer assemblies as above. The pawl (E) holds the rammers up while the articles to be rammed are arranged below. When all is in place and the first charge of clay (in the case of roman candles) is in the cases an attendant pulls the rope attached to head block, which serves to disengage the pawl. The rammers are now lowered slowly until they enter the funnel plate. The rope is now released and as the rammer head falls it rams the clay in bottom of the cases. From 5 to 15 blows are usually

required to ram each charge.

If composition becomes so dry that it will not pack firmly it should be damped with a very little water. The stars should be hard and dry and free from star dust which can be sifted out by shaking stars in a coarse sieve. The floor of ramming room also should be kept free from all accumulated composition etc. to guard against accidents from friction of the shoes or otherwise.

It should here be noted that when cutting the paper for machine rammed roman candles, a thin V shaped slip should be cut from one end (a) of sheet at side nearest the operator when being rolled. The object of this is to form a somewhat funnel shaped end to case which materially assists its easy ramming. This end must, of course, be uppermost when case is in machine. (b) (FIGURE 23, PLATE I)

The funnel plate is made of cast iron one inch thick and the other dimensions being the same as head of rammer assembly. It is drilled with 72 holes in 6 rows of 12 each corresponding with the inside of the diameter of the candles to be rammed and spaced same as the rods in rammer head. These holes are countersunk on upper side of plate, to a depth of one third thickness of plate so as to give them the shape of a funnel while the under side is counter bored somewhat larger than the outside of the candles to be rammed, which slip into these recesses and thus are held in place while machine is being operated.

This funnel plate is supported in the ramming machine by an adjustable frame attached to sides of machine, which permits it to be moved up and down as required to fit



the various lengths of cases to be rammed. This frame is not shown in drawing of machine.

#### POWDER BOX

The powder box ( FIGURE 24, PLATE II A ) is made of brass  $3/16''$  thick and its construction will be readily understood from sketch. The bottom consists of three brass plates, each  $1/8''$  thick, drilled with  $3/16''$  holes spaced at same distance as those in funnel plate. The holes in upper and middle plates are  $\frac{1}{2}''$  nearer the rear of the box than the holes in the bottom plate. The upper and lower plates are fixed but the middle plate moves forward and backward  $\frac{1}{2}''$ . When it is pushed back the holes in it and the top plate are in line, so when the box is charged with rifle powder, the holes in middle plate become filled. When the center plate is drawn forward the holes in it and those in the bottom plate come into line and the little powder charge in each hole falls out into the roman candle below it. DETAIL AT FIGURE 24 B

To facilitate the use of this box it is placed on the adjustable stand (FIGURE 25, PLATE II) whereon it can be raised to the desired height for the work in hand. This stand is made of light lumber and preferably on rollers so it may be moved into position and out of the way, as desired between charges.

The shifting boards follow the same principle as illustrated in hand ramming machine relative to arrangement of holes etc. but are of a size to fit other parts of big machine. Boards of different thickness must be provided so as to hold the required amount of composition for the differ-

ent sizes of candles rammed. The holes in star board should be slightly larger than the stars so as to permit them to fall through easily when in use. The stars for roman candles should be somewhat longer than their diameter as this makes them easier to fall into place when filling a shift board.

To fill these boards, a scoop of composition or a handful of stars is thrown on top of it; the board is shaken until the holes are evenly filled and the surplus allowed to slide off into the composition or star tray. By using boys to keep the extra pin plates and shifting boards filled as quickly as needed, and others to remove the loaded candles, a very large number of them can be loaded in a day, by one machine. A pin plate of candle cases is slipped on to the base of the machine; the funnel plate is lowered on top of it; the guide board is raised, causing the ends of cases to enter the funnel plate which is fastened in place by set screws or thumb bolts on sides of frame. The rammer head is allowed to descend sufficiently to see that all is clear. It is drawn back up into place and a shifting board of clay slipped over and its contents discharged into the candles, a slight jar being given to assure all holes of having emptied. The rammer head is now dropped some 10 or 12 times to set the clay, and withdrawn to its original position. The powder box is now slid across funnel board and by pulling handle of center plate a charge of gunpowder enters the candles. After removing powder box a board of stars is shifted into funnel plate. Care must now be used to see that all stars have slipped through funnel plate in to candles. Now a board of composition is discharged the same way and the whole rammed with about 8 to 10 blows. This

operation is repeated as often as the size of candle requires. When last charge of composition has been rammed the pin plate of candles is removed, unloaded and refilled with empty cases while another pin plate of empty cases has been slipped into its place in machine.

#### BATTERIES

A very effective piece of fireworks (FIGURE 26, PLATE II) is easily made by taking a wood box about two inches longer than the candles to be used and filling it with about three dozen 8 ball or 10 ball roman candles. The space above the candles in the box is to be filled with a few scraps of match, one piece allowed to hang over the side and a piece of cardboard nailed over for a top.

#### BOMBETTE FOUNTAINS

These are an effective combination of candles and floral shells packed in a large box as shown in FIGURE 27, PLATE I. All are lighted at once by scraps of match in the top, but the floral shells are matched so as to fire alternately, one at a time as shown, during the burning of the candles.

#### UNION BATTERY

Another interesting use for roman candles is in the so called union battery (FIGURE 28, PLATE II) which consisted originally of one battery each of candles containing white, red and blue stars. It, however, now is used effectively with candles of varigated stars.

Fireworks displays are often started with a row of vari-colored lights or bengolas set about 25 feet apart in front of the set pieces. When these are supported by a fan of candles or gerbs a very effective display is produced. The bengolas are lighted first and when they have burned half way, the candles or gerbs are lighted (FIGURE 29, PLATE II )

SKY ROCKETS

Next to roman candles these are perhaps the most popular article of the pyrotechnical craft and on good authority, seem to have long antedated the candle. So much has been written about sky rockets that any description would be superfluous. The French in particular, have left a most detailed description, sometimes amusing in view of present day conditions, regarding its manufacture.

Suffice to say that the sky rocket consists of a tube, usually paper, about seven times its outside diameter, in length, rammed with a suitable composition, its lower end choked to about one third the diameter of its bore and a hollow center extending upwards through the composition to about one inch of the top. This solid portion of the charge acts as a fuse to fire the heading when rocket reaches the end of its upward flight. A stick attached to the tube serves to balance it while ascending.

The tube is made of any good strong paper, preferably three turns of hardware on the inside and four turns or more of good strawboard on the outside but a good rocket case can be made of heavy rag or building paper if properly rolled with good paste. Choking the cases and ramming in molds has

Fig 30

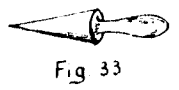
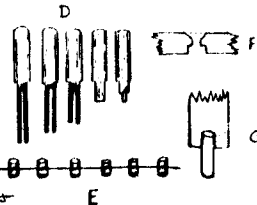
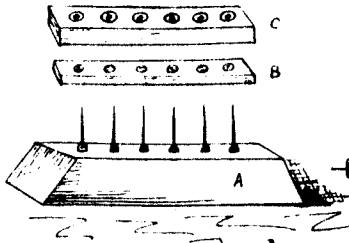
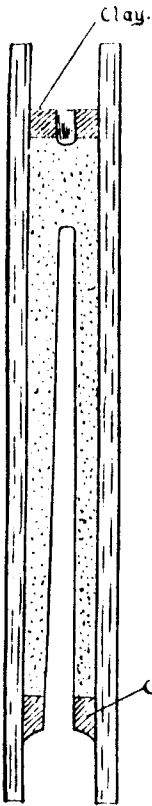

Fig 33

Fig 32

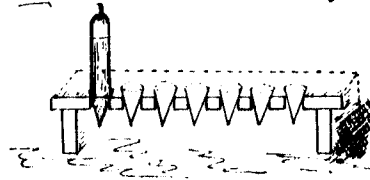

Fig 34

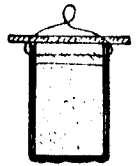

Fig 35

Flares



Fig 35 a.

To replace wood box bottom if used repeatedly.

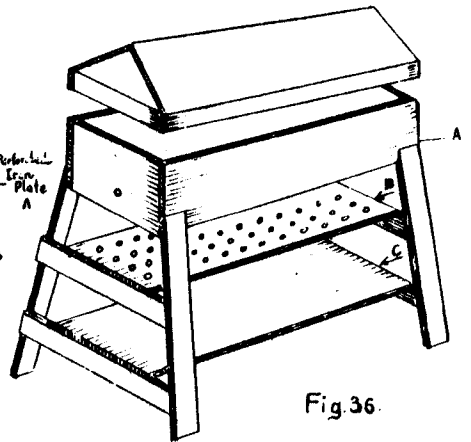
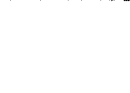
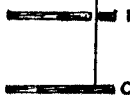
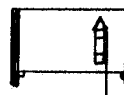
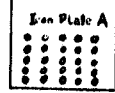

Fig 36.

1 lb. Rocket Spindle

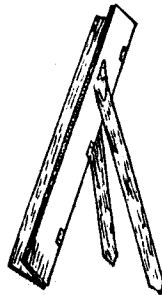
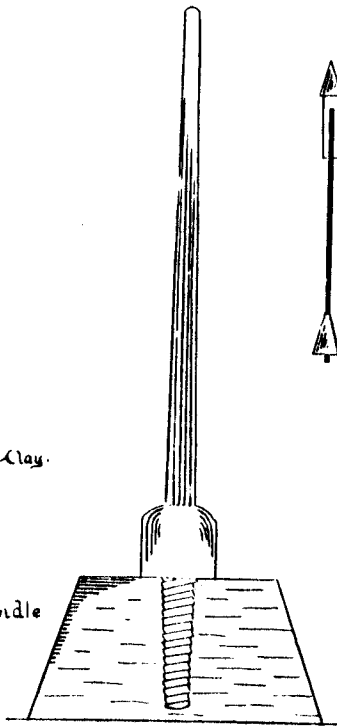

Fig 37

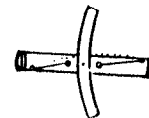

Fig 38

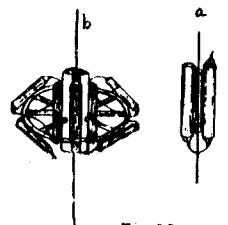
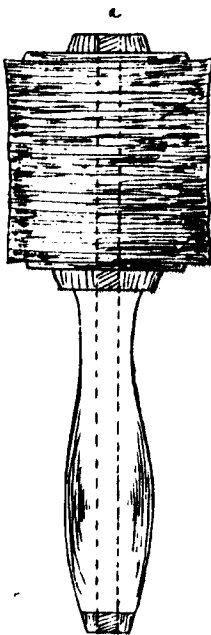

Fig 39



Rawhide Mallet



Fig 31

1 lb Rocket Ramming Tools.

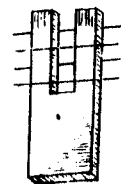

Fig 40

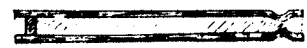

Fig 42

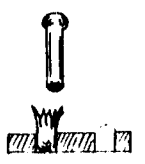

Fig 41



Saucisson  
Fig 43

Fig 44.



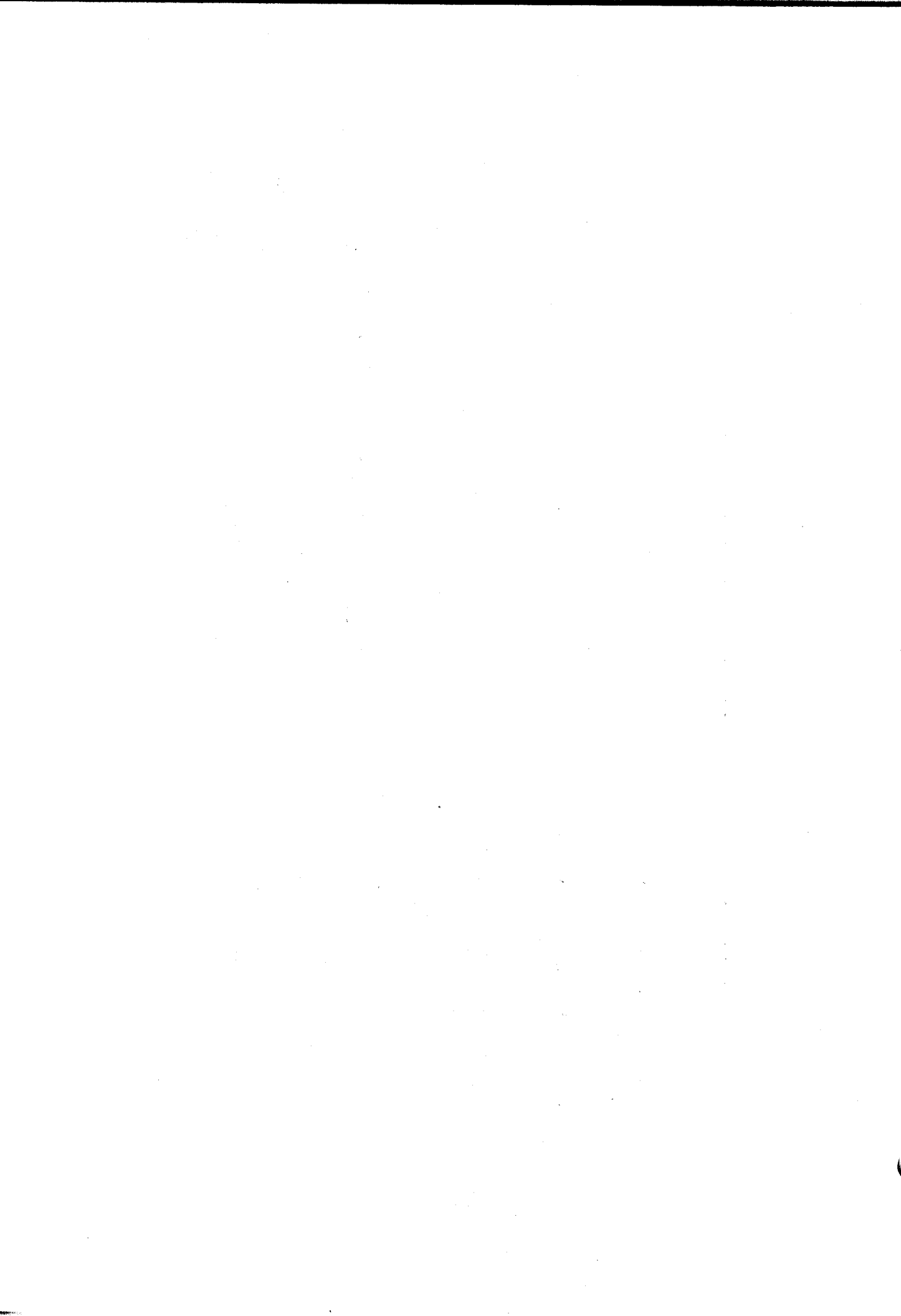

been practically discontinued.

There is no fixed rule for the length of a rocket in relation to its diameter and in practice considerable variation exists. Experiment with different sizes and compositions will determine which proportion is best suited to the particular purpose for which the rocket is desired. An average model is given herewith; FIGURE 30, PLATE III with a corresponding set of tools for ramming. FIGURE 31, PLATE III.

Good rockets should be uniform; all those of one calibre ascending to approximately the same height and exploding about the same time. Particularly is this essential in bouquets or flights of rockets of a hundred or more fired simultaneously, else a straggling effect is produced.

Most rockets larger than 3 oz. are rammed singly or by gang rammers as shown in sketch FIGURE 32, PLATE III but hydraulic rammers are also in use. \* The gang rammer is quite efficient and one man can get out a large number of rockets in a day with it. A shows the spindle block; B is the guide board for assisting to get the ends of cases into funnel piece C. D shows set of rammers while E is the set of scoops for charging the entire six cases at once. It is easily made by cutting brass shotgun shells in half and soldering them to a brass rod as shown. Details of funnel piece and hollow pin rammer used in setting top clay charge are shown at F and G respectively.

\* See Military Pyrotechnics, H. B. Faber, Vol. 2, PP 39.

One to three ounce rockets are rammed solid on the candle machine or otherwise and the hollow centre is made by driving a steel spindle into them afterwards. An efficient way of doing this is to get a mortising machine and replace the chisel with the spindle as above. A V. shaped block is set on table of machine, in such a position that when a rocket is placed in it, it will be in just the right position for the spindle to enter it. A step upon the pedal of mortising machine will force the spindle into the rocket and make the necessary hollow center.

To ram rockets from 4 oz. to 8 lb. singly, the case is slipped on spindle illustrated on page 76; a scoop of clay is shaken in and rammed by about eight good blows of the mallet on longest rammer. Then a scoopful of composition is rammed with about 8 lighter blows. This is repeated until the case is filled to within about 1 inch of the top, shifting rammers as it becomes possible to use the shorter ones. Now the final charge of clay is put in and the hollow pin rammer used. This sets the clay while leaving an opening for the fire to reach the heading. Care must be taken to see that the hollow tube just pierces the clay. If it does not go through, the heading will fail to fire; if it goes through too far heading will fire prematurely or rocket is liable to blow through before rising. See Ramming Tools FIGURE 31, PLATE III.



The following are good compositions for rockets of different sizes:

<u>1 to 3 oz.</u>	<u>4 to 8 oz.</u>	<u>1 to 3 lb.</u>	<u>4 to 8 lb.</u>
18	16	16	18 Saltpeter
10	9	12	12 Mixed Coal
3	4	3	3 Sulphur.

If rockets burst add more coal; if they ascend too slowly add more saltpeter. For the smaller sizes use finer charcoal; for the larger ones use coarser coal in proportion to their diameters. 4 to 8 lb. rockets use granulated nitre.

All rockets larger than 3 oz. are provided with a cone to contain the heading. These are made as follows:

#### SKY ROCKET CONES

Turn out a cone former on the lathe, of a shape somewhat as shown in FIGURE 33, PLATE III. Cut some stiff paper to the shape of one third of a circle, the radius of which for a 1 lb. rocket should be 3 inches. Lay it on the table before you with the round side toward the right. Paste the straight edge farthest from you and place the former on it with the point toward the left and about  $\frac{3}{8}$ " from the point on the paper where the two straight edges meet. Now roll it around the former commencing with the unpasted edge. When finished slip off former to dry.

#### HEADING ROCKETS

Prepare a board with holes through it about  $1\frac{1}{4}$ " in diameter and raised from the table about 3" as shown in FIGURE 34, PLATE III. Place in these holes a number of the cones, point down, and fill them about half full of stars, gold rain,

etc. Also a little meal powder and charcoal or candle composition. Apply gum to the upper edge of a rocket and stick it into one of these cones. Raise carefully out of the hole and press cone evenly in place. The rocket may now be wired to stick and is ready for use. In the case of shelf goods the rockets are, of course, papered and matched before attaching cones.

### SHORT STICK ROCKETS

(FIGURE 35-a, PLATE III)

These are the same as long sticks except that a stick only  $\frac{1}{3}$  the regular length is used, on the bottom of which a wing or tab of cardboard is attached. Cut a piece about 3" long,  $\frac{1\frac{1}{2}}{2}$ " wide at one end and  $\frac{1}{2}$ " wide at the other. Smear a little dextrine on one end of stick, place the tab on it, large end down and drive a 2 oz. tack through it in the middle. When dry it is ready for use. These rockets are much easier to carry about but require more care in firing to get them started straight. Model at right has no stick.

When the bottoms of brass rammers become worn from use, they may be reconditioned by battering them until they are again full sized on the ends.

There are a great many of so called fancy rockets in which the heading is not confined to a simple burst of stars etc., but is supplemented by many other beautiful effects, some of which will be described here while the ingenuity of the pyrotechnist must be relied on for others.

### WILLOW TREE ROCKETS

These are made by filling a large rocket head with pieces of Japanese Star and a weak bursting charge. If the bursting is too strong many pieces will fail to light.

### PRIZE COMETIC OR SHOOTING STAR ROCKETS

These are prepared by placing 4 or 5 four ounce rockets, without sticks, in the head of a 6 lb. rocket besides a handful of box stars. A few #1 stars are also placed in the top of each of the 4 oz. rockets with a pinch of grain powder, and well capped.

### GOLDEN CLOUD ROCKETS

For these the rocket head is filled half full each of gold rain and aluminum stars. The weight of the contents of a rocket head must be proportioned to the size of the rocket. A heading of heavy stars must be smaller than one of lighter materials.

### BOOM ROCKETS

Have one or more small maroons in the head besides a few stars.

### ELECTRIC SHOWER ROCKETS

Made by filling a small head with electric spreader or granite stars. As these are very heavy only a small quantity can be used.

### BOMBSHELL ROCKETS

These have a small shell with very short fuse fastened to top of rocket, with a few stars in the head of the rocket itself, which burn before the shell bursts.

The head of this rocket is filled with whistles, made as described under that caption. In addition, a few colored stars are added.

LIQUID FIRE ROCKETS

These are one of the most beautiful pyrotechnical effects known to the art. Take a 3 lb. rocket and fill the space above the clay with grain powder. Cover this with a circular piece of perforated paper secured by a strip of tissue paper. Roll on a head of about three turns of strong manilla paper, only pasted on the edge, about 6" long. Now procure some sticks of phosphorus and cut them under water with a chisel into pieces about  $\frac{3}{4}$ " long. Get some  $\frac{1}{4}$  lb. tin cans, punch a number of holes at the bottoms of them and fill with the pieces of phosphorus, conducting the entire operation under water. When ready to fire the rockets remove one of the cans from the water, allow to drain for a few seconds, empty contents into one of the rocket heads, tuck in and fire at once. Great caution must be observed owing to the dangerous nature of the phosphorus.

PARACHUTE ROCKETS

To successfully launch a parachute from a shell or rocket requires the greatest care and skill, besides patient attention to every detail or the light fabric will either fail to unfold or be torn or burned in its exit from the tube in which it is placed.

To begin with procure some very light Japanese tissue paper; cut into squares about 18" each way and rub thoroughly

with powdered soapstone. \* Cut four pieces of stout linen twine or shoemakers thread about 18" long. Twist the corners of the tissue squares a little and tie a thread to each. Draw the other four ends of threads together and tie them in a knot. The parachute is now ready to fold. In one hand take the knot where the four strings meet and in the other take the top of the parachute by the center. Draw the hands apart until the paper folds together and lay on the table in front of you. Straighten out the four folds, two each way, and fold them again laterally toward the center about five or six times like the bellows of an accordion until the pile is about 1 inch wide. Now roll this up lightly, begin at the small end or tip until you come to the strings, then wind the four strings, also lightly, around the bundled parachute until it will just about fit the rocket head for which it is intended.

For making the light ram a short case  $\frac{3}{4}$ " diam. and 1" long with box star composition. Prime one end and stop the other with clay. Over clayed end glue a cardboard disc slightly smaller than inside diameter of rocket head, having first passed a wire through the case under the disc so as to form a loop on exposed side as shown, FIGURE 35, PLATE III. Pass about 18" of stout linen twine through the wire loop and tie the other end to the knot on the parachute where the four strings come together. Roll a piece of naked match about 18" long, into a bunch and place it in the bottom of the rocket head for a blowing charge. On top of this drop the primed end of the parachute light and over it place a small wad of cotton waste and a little cotton hulls or bran. Now slip in the parachute around which the strings have been lightly wound.

-----

\* Ready-made parachutes may now be purchased from stock.

Fill all around parachute with bran and secure the top of rocket head very lightly so the parachute will be thrown out when discharged, with the least possible effort.

### CHAIN ROCKETS, ( CATERPILLARS )

If you have succeeded with parachute rockets you may now attempt this modification of the above which is infinitely more difficult, but their great beauty compensates for the trouble required in their preparation. A parachute several times larger than the first described is made in substantially the same manner but preferably octagonal with the separate pieces sewed together. Instead of one light, a dozen or so of different colored lights are attached to it. This is called the chain and to launch it successfully from either rocket or shell is about as difficult a proposition as the pyrotechnist is called upon to execute.

For the lights composing the chain ordinary lances may be used. To a 4 lb. rocket take 12. Procure a strong linen twine about 18 ft. long. To this attach the lances at intervals of about  $1\frac{1}{2}$  feet, by taking two half hitches around the bottom ends. ( It is best to make special lances for this purpose, filling the first  $\frac{3}{8}$ " at the bottoms with clay). When all are fastened, tie one end of chain to parachute and at the other begin to wind up the slack between the lances. Wind each lance with the slack between it and the next one to it, winding as smoothly as possible without lapping the twine anywhere. As each one is wound lay it against the one before it until the 12 are in a round bundle. Then take a few turns

around the entire bunch on upper end, so as to hold it together. At the bottom end of bunch take 2 turns of light cord not more than  $\frac{1}{4}$ " from the end. This is to hold the lot together until the lights all take fire when this cord burns off and chain unwinds in the air. A cardboard wad fitting easily in the rocket head and with a hole through its center is placed on top of the primed ends of the bunch of lances and a piece of match passed through the hole in same so as to touch them. This may be fastened in place with a small tack or two.

Now prepare the rocket head for the reception of the chain, as directed for parachute rockets, by placing about 2 ft. of naked match in bottom of head for the blowing charge. Slip the bunch of lances on top of this with another paper disc, through which line runs, over it. Put in a good wad of cotton waste, then the parachute carefully folded as described and pack with bran. Now cap the rocket head as lightly as possible and if all directions have been carefully followed, the chain will be likely to come out successfully. A few trials, however, are generally necessary. Sometimes four light sticks are inserted in rocket head alongside of the parachute the lower ends resting on a stout wad under the bunch of lances and the other ends against top disc over parachute. This is to keep parachute from being injured while being expelled by blowing charge.

#### BOUQUET OR FLIGHT OF ROCKETS

These are made by firing a hundred or more rockets at once from a specially prepared box. Take three boards of  $\frac{1}{2}$ " lumber, 12" wide and 4 ft. long; clamp top of them together

and with a  $\frac{1}{4}$ " bit bore 5 rows of holes 2" apart and beginning 2" from the sides and ends. This will make 100 holes through the boards (B). Now make a box, the bottom of which is made of one of the boards with holes through it as shown in FIGURE 36 (A) PLATE III. Attach four legs to the box, about  $4\frac{1}{2}$  feet long. At  $1\frac{1}{2}$  feet from the bottom secure the other board with the holes in it, (B) so that a rocket passed through a hole in the box bottom may be steadied by passing through corresponding hole in lower one. Fit the third board (C), in the legs also, about 6" from the ground to make a resting place for the rocket sticks and so as to hold the bottoms of the rockets in box, about one inch above bottom board (A) of box. This is to permit the fire to reach all the rockets instantly when flight is lighted.

Flight rockets used this way need not be matched; only primed and a little loose grain powder thrown on bottom, inside of box and a piece of match passed through a hole in side to fire it from, is all that is required. If a top, covered with canvas, is fitted to flight box, same may safely be left in the rain until required. Some pyrotechnists make flights by stringing rockets in a row on slats provided with nails to hold them apart but the effect is much inferior.

#### ROCKET STAND

The best method of firing sky rockets is from a wooden trough constructed of two light boards,  $\frac{1}{2}$ " thick, 4" wide and 6' long. These are nailed together so as to form a gutter and supported by two legs. If the boards and legs are hinged as shown in FIGURE 37, PLATE III, the trough may be



folded and easily carried about.

### TOURBILLIONS

(GEYSERS, WHIRLWINDS, TABLE ROCKETS)

This is a modification of the sky rocket and ascends to a height of about 100 feet, in a spiral manner and without a stick. They are made by ramming a 3 lb. rocket case with the following mixture:

Salt peter	8	5
Meal Powder	7	12
Charcoal	2	3
Sulphur	2	3
Steel Filings	3	

Both ends of the case are stopped tight with clay. Four holes are bored in it,  $\frac{1}{4}$ " diam. Two are bored into the bottom. 3" apart or  $1\frac{1}{2}$ " each way from the center and one hole on each side, 1" from end and opposite to each other as shown in sketch FIGURE 38, PLATE III. A piece of curved stick, as long as the case is nailed to the bottom of case, exactly in the center and at right angles with same. The holes are primed and while still wet it is matched by tacking a piece of quick match to one of the bottom holes, passing it to the nearest end hole; then over the top to the other end hole and finally to the other bottom hole. A small hole is now made in the match pipe as it passes over the top of case, just in the center, into which a short piece of raked match is slipped for lighting. To fire a tourbillion it should be laid on a wide board or smooth surface and lighted with a long portfire.

Small tourbillions are sometimes made by boring only two holes in the under side of case, at an angle of  $45^{\circ}$  from the perpendicular, but those with four holes, especially in

the larger sizes are safer and more likely to function. They may also be matched by using naked match all around and afterwards covering the whole tourbillion with tissue paper pasted and pressed closely to same. Large tourbillions are sometimes further beautified by placing a few stars in the ends of the case, outside of the clay, boring a small hole through same and securing over top with strong paper and a wad. A little meal powder is put in with the stars and when the tourbillion reaches its height, these are thrown out with fine effect.

### FLYING PIGEONS

This amusing piece of fireworks is easily made in its simplest form by securing two rockets with their openings pointing in opposite directions, to an empty case as shown in FIGURE 39, PLATE III (a) The rear end of one is connected by a piece of match to the front of the other. A piece of thin rope or telegraph wire is stretched between two posts about 20 ft. high and 300 ft. apart. One end of wire is previously slipped through the empty case forming the middle of pigeon. On lighting the first rocket the pigeon will run along the line until the other rocket lights when it will return to the starting point.

A more elaborate form of pigeon (b) is made by procuring a frame as shown. This consists of a vertical wheel frame with a heavy slotted hub. A row of 4 wheel cases are fastened to the rim and four 1 lb. rockets are secured to the long slots in hub, two pointing each way. The pigeon starts with one of the wheel cases; the rear end of this is connected to one of the rockets, this in turn is matched to the second wheel case and that to the next pointing in the

opposite direction and so on to the last rocket.

#### ENGLISH CRACKER OR GRASSHOPPER

Cut some good 20 lb. 24" x 36" manilla or Kraft paper into strips 4" wide and 12" long. If cut with the grain of the paper as it should be this will give 18 cuts from one sheet. Roll them into short tubes as directed for match pipes, getting the opening at one end, somewhat larger than that at the other. This may be done by rolling a V shaped strip of paper on one end of rod. When a quantity of these tubes have been rolled close the smallest end by twisting or folding it over. Dry them in the shade and put about 12 dozen in a bundle, all the open ends one way. Stand the bundle on a large sheet of paper with the open ends up and pour FFF rifle powder on top of it until all the tubes are full. Jolt bundle occasionally to be sure none are only partly filled. Then draw them out, closing the top end as you did the bottom and wrap them all in a wet towel, setting aside in a damp cool place for several hours. A good way is to take a long cloth, wet it well, spread the loaded pipes loosely on it and roll it up so that each pipe will touch part of the wet cloth as they should be moistened through but not wet before proceeding further. When this condition has been reached ( on which the whole success of the operation depends) run them through a clothes wringer or other roller so that they will be somewhat flattened. The exact amount of flattening can only be found by experiment.

Now take a piece of wood, say 1" thick and 4" wide by 18" long. Notch out a piece as shown in FIGURE 40, PLATE III,  $1\frac{1}{2}$ " wide and 6" deep and procure a dozen pieces of stiff

wire 4" long. Lay the lower ends of a half dozen of the damp pipes across the bottom of the notched board which has been fastened in an upright position to a bench. On top of these and against one side of the board lay a wire and bend the pipes across over it until they now point in the opposite direction. Lay another wire as before but on opposite side and repeat the operation until the entire length of the pipes have been folded up. Then take a bar of wood shaped as shown in sketch and, holding one end in each hand press the folded pipes down as hard as possible so as to have the turns well formed. Now lift out the folded bunch, wires and all. Remove wires, fold bended pipes, one by one in the hand and with linen shoemakers thread secure them by wrapping half a dozen turns around the folded pipe and finally pass a few turns between the folds. Strip off one end so the powder is exposed and prime it with a little wet powder or match it; or the end may be twisted up with touch paper, made by coating unglazed paper with a solution of saltpeter, before folding. When dry crackers are finished.

In this country a cruder form of cracker is made by taking suitable lengths of Covered Match damping and folding it like the crackers described, tying and leaving a short piece of match protruding for lighting it.

#### PIN WHEELS

For making these proceed just as described for English Crackers except using the following composition instead of gunpowder for loading them:

Meal Powder		10	8
Fine grain Powder	8	5	8
Aluminum			3
Saltpeter	14	4	16
Steel filings	6	6	
Sulphur	4	1	3
Charcoal	3	1	8

When they are damped and rolled out punch out a lot of round pieces of #60 Strawboard, with a hole through their center. Then get a piece of brass, the same size as the cardboard centers and fasten it to the work table. Lay one of the centers on this brass plate and taking a filled pinwheel tube press the smallest flat end against its edge and twisting it around disk with the right hand while left hand feeds the tube as it is being wound on, continue until all the tube is rolled around the center. The brass plate should be half as thick as the finished pinwheel so the cardboard center will be held just about in the middle of the pinwheel while it is being twisted.

Now have some boards prepared with strips of wood  $\frac{1}{4}$ " square, nailed on them, the same distance apart as the width of a pinwheel when it is lying down. When the wet pinwheel is twisted up as above, lift it off the brass plate and set it between two of these strips on the board so as to keep it from untwisting and with a brush put a drop of glue across the pipes and onto the center disc, at four equi-distant points. When they have dried they may be removed from the boards and are ready for use. FIGURE 41, PLATE III.

SERPENTS OR "NIGGER" CHASERS.

( SQUIBS )

These are light strong cases, 3" to 5" long, crimped at

one end and charged with a sharp composition, strong enough to cause them to run around on the ground or in the air while burning. They may be made from #140 strawboard, heavy manilla or rag paper and crimped while still wet. FIGURE 42, PLATE III.

They may be rammed singly with rod and funnel or in batches of 72 at a time with the hand combination rammer. q.v.

Alternate compositions are:

Meal Powder	3	3
Saltpeter	2	5
Sulphur	1	1
Mixed Coal	1 $\frac{1}{2}$	3
FFF Grain Powder	4	3

#### SAUCISSONS      FIGURE 43

These are very similar to serpents but somewhat larger and always end with a report. The usual length is 3 $\frac{1}{2}$ " with a diameter of  $\frac{3}{8}$ " to  $\frac{1}{2}$ ", rolled and crimped like serpents though with a heavier case. Ram with.

Meal Powder	4
Saltpeter	2
Fine Coal	1 $\frac{1}{2}$
Sulphur	1

For exhibitions, about three dozen of these are put in a paper bag with three ounces of blowing charge composed of half meal powder and half grain powder. A piece of match a yard long, bared for an inch or two is stuck into the mouth of the bag and tightly secured with a string. When ready for use it is loaded into a mortar and match ignited.

For stock work a paper mortar is made by rolling six or eight thicknesses of heavy strawboard 12" wide around a former 2 $\frac{1}{2}$ " diam. A wooden bottom is fitted and a mine bag made as described under MINES. The saucissons are placed in same with blowing charge, around a 10 ball roman candle from

which the bottom clay has been omitted. This is placed in the paper mortar with a daub of glue on bottom of bag. A top is fitted as for mines and when papered and striped, is ready for the market.

### M I N E S

These are small paper guns from 1" to 3" in diam. in the bottom of which is placed a small bag of stars, powder etc., which is fired by a mine fuse or roman candle in which the charge of clay has been omitted and replaced by one of candle composition. The bottoms are turned out of wood. The tubes are made by tightly rolling six to twelve thicknesses of strawboard, around a suitable former. Following are approximate sizes:

<u>NUMBER</u>	<u>HEIGHT</u>	<u>DIAMETER</u>	<u>NUMBER OF STRAWBOARD</u>
1	4"	1 $\frac{1}{2}$ "	1 sheet of #140
2	4 $\frac{3}{4}$ "	1 $\frac{5}{8}$ "	1 sheet of 120
3	5 $\frac{1}{8}$ "	2"	1 sheet of 100
4	7"	2 $\frac{1}{4}$ "	2 sheet of 100
5	8 $\frac{1}{2}$ "	2-3/8"	3 sheet of 100
6	10"	2-7/8"	4 sheet of 100

No. 1 mines take a 1 ball mine fuse; #2 mines a 2 ball fuse etc.

The mine bags are made by boring a number of holes into a thick board; (for #1 mines, 1 $\frac{1}{4}$ " diam. and 1 $\frac{1}{2}$ " deep). Then make a punch with rounded edges; ( for #1 mines, 1" diam. ) and over this press a piece of stout paper (about 4" square) closely around end of punch and shove it into one of the holes in the board; remove punch; insert a mine fuse and around it put a half ounce of stars and a teaspoonful of blowing charge. Squeeze loose ends of bag around fuse and secure with a piece of string or wire. Now dab the bottom of bag with a little

dextrine or glue and insert it in one of the paper guns into which a bottom has been previously glued. A top is now necessary. This is made by adjusting an ordinary washer cutter to the requisite size so as to cut a piece of strawboard with the outside diameter of the gun and center hole of the size of the mine fuse. When this is slipped into place over the fuse it is secured by a square piece of paper, an inch or two larger than the top of mine and with a hole punched in the middle with a wad cutter, to fit over mine fuse. Paste and press closely about the top of mine and when dry same is ready for use. For stock work they must, of course, be papered and striped, packed and labelled. Mines of saucissons are made by substituting saucissons for the stars. FIGURE 44, PLATE III.

#### DEVIL AMONG THE TAILORS

These are made by taking a large short mine case and filling the bag with tailed stars, serpents and English crackers. Besides the central candle for firing it, four more candles, one at each corner on the outside of gun are fastened and connected so as to burn at same time. FIGURE 45, PLATE IV.

#### ANGLO JAPANESE MINES

These consist of a #6 mine case containing a bag filled with colored stars and Jap or Willow Tree stars. Electric Spreader stars with crackers also make a handsome mine. The various effects are almost unlimited and the genius of the artificer will suggest other combinations.



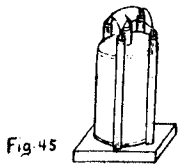
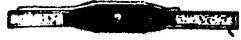
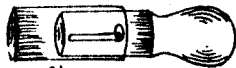

Fig. 45



Saxon Fig. 52.



Star pump Fig 53.



Fig. 46



Fig. 47



Fig. 48



Box Star. fig. 54.

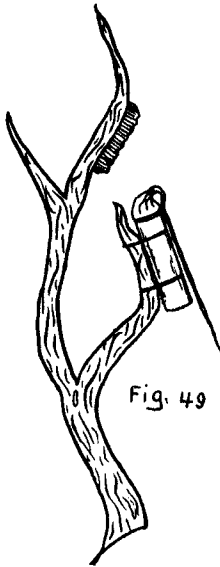
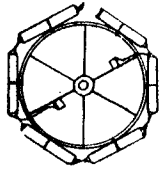
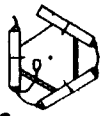

Fig. 49



Triangles Fig. 50



Vertical Wheel Fig. 51.

Star plate assembly Fig. 55.

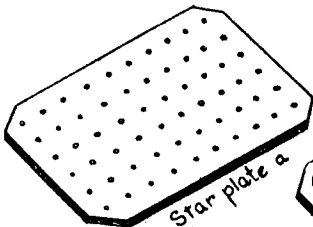

Star plate a

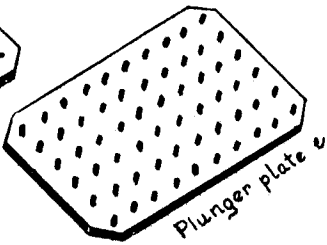

Plunger plate c

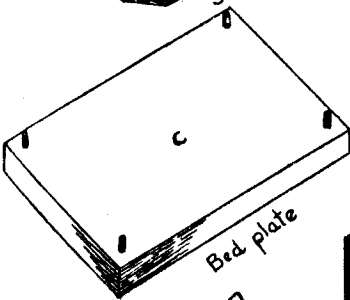

Bed plate

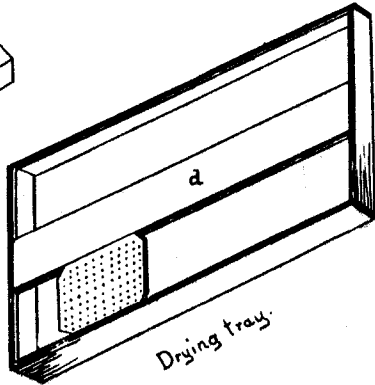

Drying tray



Knife Scraper.

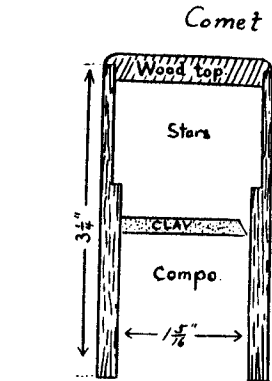
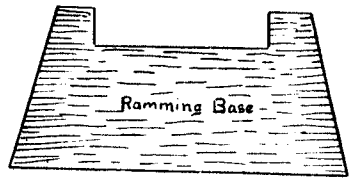

Fig. 56



Ramming Base

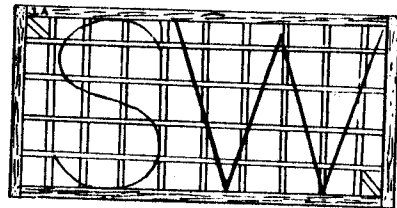

Fig. 57

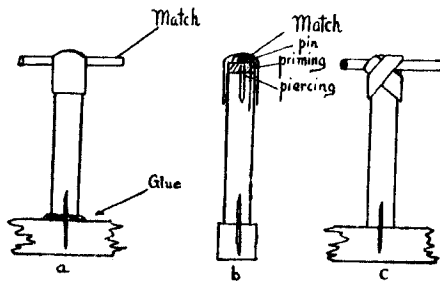

Fig. 59

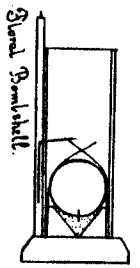

Fig. 60

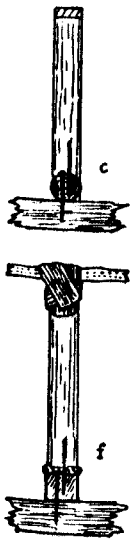

Fig. 58

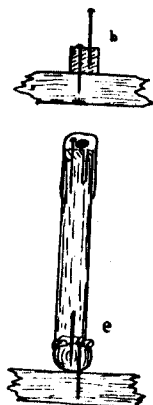
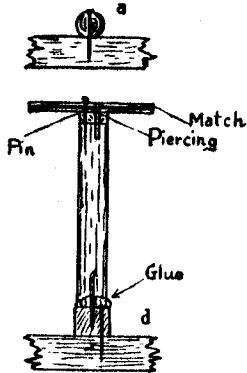

Fig. 61

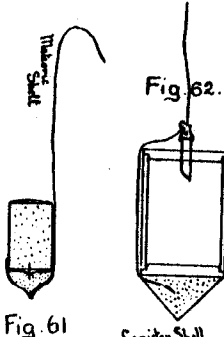

Fig. 62

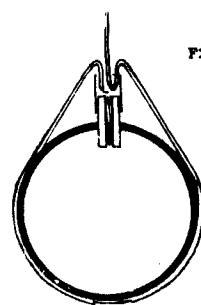
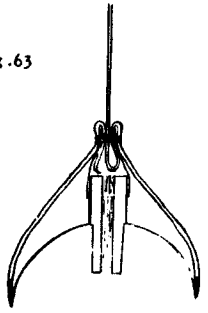

Fig. 63





## GERBS, FOUNTAINS AND FLOWER POTS

These are all modifications of the same principle which is a paper tube or case varying from  $\frac{1}{2}$ " diam. to 2" diam. rammed solid with one of the compositions to be given later.

### G E R B S.

#### FIGURE 48, PLATE IV.

These are used for all set pieces where brilliant effects or jets of fire are desired. They should be about  $\frac{5}{8}$ " diameter and 9" long. When steel filings are used the steel should be first protected q.v. as the saltpeter corrodes the filings which affects their brilliancy. They are rammed like rockets but on a short nipple without central spindle.

### FOUNTAINS

#### FIGURE 46, PLATE IV.

Are usually from 1" to  $1\frac{1}{2}$ " diam. and 12" long with a wooden point in the lower end so it can be stuck in the ground for firing. A quarter ounce of rifle powder is sometimes placed after the last charge of composition and before the clay. both in fountains and gerbs so as to have them finish with a report or "bounce".

Besides the regular composition with which fountains are charged, if the calibre permits, small colored stars cut to about  $\frac{1}{4}$ " cubes and placed between the charges when ramming, greatly increase their beauty and they are then called FLORAL FOUNTAINS or PRISMATIC FOUNTAINS. There is however, some danger in ramming stars containing free sulphur and this may be avoided by using composition free from chlorate, such as granite stars, copper borings etc. or perchlorate.

Cascade cases are used for water falls and such designs where the fire is required to fall considerable distances to the ground. They are usually from  $1\frac{1}{2}$ " to 2" diam. and 12" long. Where this piece is to be often repeated as at Fairs, iron tubes 2" inside diam. are sometimes used as these are stronger and can be cleaned with kerosene after using for repetition. Where Niagara Falls is shown this form of case is in general use as it saves the rolling of 200 to 300 large cases for each display.

### FLOWER POTS

FIGURE 47, PLATE IV.

Small cases, choked,  $\frac{1}{8}$ ",  $\frac{3}{8}$ " and  $5/8$ " diam. and from 5" to 10" long with a wooden handle in end provide a pretty piece of fireworks for use by ladies and children. When properly made they are perfectly safe to fire from the hand but this fact should be assured by first firing a few by sticking them in the ground, to see that the charge is not sufficiently strong to burst the case. The lampblack in these produces a peculiar effect not entirely understood.

It might be well to mention that when ramming gerbs etc., it is advisable to begin with one charge of starting fire especially where the composition contains steel, as they not only sometimes miss fire but there is also the likelihood of striking fire by ramming steel filings against a metal nipple. Use the following formula.

### STARTING FIRE FOR GERBS

Meal Powder	4
Saltpeter	2
Sulphur	1
Charcoal	1

GERBS

Meal Powder	6	4
Salt peter	2	
Sulphur	1	
Charcoal	1	1
Steel filings,	1	2

FOUNTAINS

Meal Powder	5
Gran. Salt peter	3
Sulphur	1
Coarse Charcoal	1
FF Rifle Powder	( $\frac{3}{4}$ )

FLOWER POTS

Salt peter	10
Sulphur	6
Lampblack	3
FFF Rifle Powder	6

GRANITE STAR

Salt peter	14
Zinc Dust	40
Fine Coal	7
Sulphur	2 $\frac{1}{2}$
Dextrine	1

CASCADES

	1 $\frac{1}{2}$ " CASE	2" CASE
Granulated Salt peter	18	16
Mixed Charcoal	4	4
Sulphur	3	3
Iron Borings	6	7

WASP LIGHT

This contrivance supplies a very effective and safe method of destroying the nests of wasps, hornets etc. The sketch illustrates the method of using same and the following composition is satisfactory.

Salt peter	9
Sulphur	1 $\frac{1}{2}$
Charcoal	5

Where it is not practical to attach the light as shown, a long pole may be used. Tied to the end of a fishing rod and brought in contact with a nest it will destroy it without danger to the operator as the burning composition completely demoralizes the insects who make no effort to sting.

The case should be about  $\frac{3}{4}$ " dia. and 5" long, rammed on a nipple like a gerb. FIGURE 49, PLATE IV.

### REVOLVING PIECES

#### TRIANGLES

These are made in two forms, FIGURE 50, PLATE IV.

(a) consisting of a small six sided block with concaved grooves on three of its edges into which small choked cases are fastened, either by glue, wire or nailed; and (b) consisting of a triangular block on each side of which a serpent is fastened. The serpents must be rammed full and primed at both ends, except the last one. A piece of paper is pasted over the joints where the two ends meet, of second and third cases and first one is matched with a small piece of match for lighting. The blocks have a hole through their center for the nail on which they revolve.

In making the larger triangles (a) take 3 small choked cases  $\frac{1}{2}$ " diam. Ram 2 of them with triangle composition to within  $\frac{5}{8}$ " of the end; then stop ends with  $\frac{1}{2}$ " of same composition moistened with dextrine water and ram tight with solid rammer. The 3rd case should be closed with clay. Now cut papering 2" longer than the case and cover in the regular way. Into the choked ends after priming, twist a piece of

match  $1\frac{1}{2}$ " long, except the first one where a shorter piece will suffice. Now fasten them to block as described above, first the one with clayed end, then one with both ends open and finally the one with short match. Insert match of third case into nosing of second one and match of second case into end of first and secure the joints with pasted tissue paper.

### VERTICAL WHEELS

FIGURE 51, PLATE IV.

Made by fastening 4 to 8 driving cases to a wooden wheel made for this purpose. The cases are usually  $\frac{1}{2}$ " to  $\frac{5}{8}$ " in inside diameter, either choked or rammed on a nipple with clay. They are papered and matched the same as for triangles, except that the connecting matches should be papered as the distance between cases is greater than in the triangles. A little gum on the side of case where it touches the rim of wheel will hold it more securely than wire alone. The wood wheels for these may be obtained in North Weare, N. H.

### SAXONS

FIGURE 52, PLATE IV.

Ram two cases  $\frac{1}{2}$ " to  $\frac{3}{4}$ " inside diam. with a strong composition, closing both ends with clay and gluing them to a block as shown. A hole is bored  $\frac{1}{4}$ " diam. and just through case, as near to clayed ends as possible and at right angles with the nail hole in center of block on which saxon will revolve. These holes must, of course be on opposite sides. A piece of match is fitted into one of these holes and secured with pasted paper while another hole is bored into bottom of case

but on side opposite to that of first hole. From this hole a piece of match is led to hole in second case; fastened with a tack and well secured with pasted strip.

Colored pots are attached to wheels and saxons greatly enhancing their beauty, by ramming light cases  $\frac{3}{4}$ " diam and 2" long, with torch composition. They are fastened to the piece as shown and usually matched to the second case. Also on larger vertical wheels the composition of the various drivers is varied so as to increase their effect as burning proceeds. The first case is charged with plain driving composition; the second with steel filings added; the third with granite stars etc.

#### TRIANGLE COMPOSITION

Salt peter	18	12
Sulphur	2	8
Mixed Charcoal	5	5
Rifle Powder FFF	12	12

#### WHEEL CASES ( Drivers )

Meal Powder	8	3
Salt peter	3	2
Sulphur	1	1
Mixed Charcoal	1	1
F Rifle Powder	1	
Lampblack	$\frac{1}{8}$	
Steel filings ad.lib.		

#### SAXONS

Meal Powder	4
Sulphur	2
Salt peter	2
Mixed Charcoal	1



This subject covers probably the most comprehensive division of the art of fireworks making. Besides the endless variety of colors, effects etc., we have the cut star, box star, pumped star, candle star etc. Nearly all stars are made by dampening the composition with water ( if compo. contains dextrine) or alcohol ( if it contains shellac) and pressing the caked mass into little cubes, cylinders etc. by the various devices to be described.

C U T S T A R S

are about the simplest form of star made. The composition is moistened with water until a handful when squeezed retains its shape and does not fall back as powder. The most convenient way to moisten all compositions is to have a large dishpan or small painted tub into which the composition is put, and water added little by little, being worked in and rubbing the damped portions between the hands until it is evenly moistened. Cut stars must be damped slightly more than pumped stars or they will break and crumble in cutting. When the proper amount of moisture has been added dump out on a board or stiff piece of paper, press into flat cake about  $\frac{1}{2}$ " thick much as biscuits are made and then with a large knife make cuts through it at right angles about  $\frac{3}{8}$ " apart. When thoroughly dried the little cubes may be broken apart for use. On account of the ease with which these stars light, owing to their many sharp corners, they are particularly adapted to rockets, small shells etc. where smoothly made stars are liable to miss fire.

J A P A N E S E   S T A R S

This beautiful effect is made somewhat similar to the above. The great difference between the bulky lampblack and the compact potash makes it quite difficult to mix them thoroughly and this is particularly necessary to obtain good results. Furthermore it is hard to get lampblack to take up water. It is therefore necessary first to moisten it with alcohol when it will take the water more readily. The method which I have followed with best success is as follows:

	#1	#2
Lampblack	12 oz.	6 oz.
Chlorate Potass:	8 oz.	4 oz..
Saltpeter	1 oz.	
Water	18 oz.	9 oz..
Alcohol	4 oz.	2 oz.
Dextrine	1 oz.	
Gum Arabic		$\frac{1}{2}$ oz.

Mix dextrine and saltpeter (formula 1) well together and add sufficient water to make a gummy liquid. Boil the balance of the water and add the Chlorate Potass; to it. Put the lampblack in a large pan and pour the alcohol over it working it in as well as possible. Now add the chlorate potass; and the hot water and stir with stick until cool enough for the hands and lastly add the dextrine and saltpeter. Remember that you cannot mix it too well and the effect will be in proportion to the evenness with which this has been done.

Take some pieces of light canvas or ticking about 18" square and put one or two handfull of composition into one, spread it about an inch thick in center of cloth, folding same over it, and place under a strong press of some kind. Fold up another cloth of composition in a similar manner and place on

top of first. Repeat until 4 or 5 cloths are under press and screw up as tightly as possible and until surplus water runs out freely. Open press, remove cakes from cloths, dry for about two weeks and break into pieces about  $\frac{1}{2}$ " square. It is important that the lampblack is perfectly dry and free from oil to get the best results and it is sometimes necessary to pack a jar or crucible with it and heat in a bright fire until all volatile impurities are expelled. You will then have one of the most beautiful effects of the entire fireworks art.

In recipe #2 the potash and lampblack are sifted together several times; add alcohol; then water in which gum has been dissolved and proceed as in recipe #1.

#### B O X   S T A R S

Where the best and handsomest effects are required this form of star is undoubtedly the most adaptable to the purpose. First, they burn much longer than others; second, they are less liable to go blind and furthermore they will stand more blowing from a shell than any other form of star.

FIGURE 54, PLATE IV.

Make some light cases of about 4 thicknesses of stout manilla paper 6" to 12" long on a  $\frac{1}{2}$ " former. Cut with a scissors into  $\frac{5}{8}$ " lengths. Cut some thin match into lengths of an inch or a little over. Pass a piece of match through one of the little pieces of case or "pill box", bend the ends slightly around the edges as shown in illustration and dip it into a pan of composition previously dampened as described before. Then with the first and second fingers of the right hand press the composition into it as firmly as possible until it will

hold no more. Dry in the sun for 2 or 3 days.

### P U M P E D   S T A R S

These are used more than any other form of star on account of their regularity and the ease and speed with which they can be made, being even more quickly made than cut stars where the proper appliances are at hand. Where only a few are required, a hand pump FIGURE 53, PLATE IV. will do very good work. All that is necessary is to draw up the plunger press the pump into damp compo, until filled and by pressing the plunger while holding the tube, a star is ejected. When they are required in large quantities, however, star plates are necessary-FIGURE 5, PLATE IV.

With these 200 or 300 stars are made almost as quickly as one by hand pump. A good idea may be obtained by reference to FIGURE 55, PLATE IV. The standard sizes of stars are about as follows:

<u>#1</u>	<u>#2</u>	<u>#3</u>	<u>#4</u>
$\frac{1}{4}$ " Diam.	5/16" diam.	3/8" Diam.	7/16" diam.
3/8" long	7/16" long	$\frac{1}{2}$ " long	9/16" long.

Consequently the plate for making a #1 star must be 3/8" thick and have holes  $\frac{1}{4}$ " diam. (a) The others, in same proportion. The plungers on plunger plate (e) must be somewhat smaller in diam. and slightly longer than the holes in star plate so they will move freely and force the stars completely out. The plates are about 4" x 6" square. Trays for holding the stars while drying (d) should have the bottoms made of brass wire netting so as to permit free circulation of air through the stars, enabling them to dry in a few hours. The center strip as well as the sides of the tray on top should be rabbetted

so as to hold the star plate while stars are being pumped.

In order to make stars with a star plate, moisten a batch of composition in a dish pan with water as heretofore described and empty same on a rather high work table previously covered with a square yard of rubber cloth. Press the plate (a) into same until the composition comes up through the holes. Then with the scraper knife (b) work more compo. down into the holes until they appear full. Scrape off all surplus compo. and remove to the iron bed plate (c) putting down the side previously up and press more composition in with the scraper. Then all the holes are well filled scrape off surplus thoroughly, place in rabbet of tray and with plunger plate pump out the stars. Care must be taken to have the right side of the plate up when pumping or plungers will not fit holes. If the plate begins to work badly on account of the composition drying on plungers same must be washed before using again. The proper dampness for composition can only be ascertained by practice. If too dry stars will crumble. If too wet they will not ignite freely.

FORMULAS FOR CUT, PUMPED OR CANDLE STARS

WHITE STARS

Salt peter	50	54
Sulphur	15	15
Red Arsenic	15	9
Dextrine	3	3
Black Antimony		15
Red Lead		6
Shellac		1

RED STARS

Chlorate Potass	6	24
Shellac or red gum	1	3
Fine Charcoal	2	4
Carbonate Strontia		4
Nitrate Strontia	6	
Dextrine	$\frac{1}{2}$	$1\frac{1}{2}$

BLUE STARS

Chlorate Potass	24
Paris Green	9
Nitrate Baryta	8
Shellac	5
Dextrine	$1\frac{1}{2}$

GREEN STARS

Chlorate Potass.	6
Nitrate Baryta	6
Fine Charcoal	2
Shellac or KD Gum	$1\frac{1}{2}$
Dextrine	$\frac{1}{2}$
Calomel ad lib.	$\frac{1}{2}$

YELLOW STARS

Chlorate Potass.	16	16
Shellac or red gum	3	3
Fine Charcoal	4	1
Nitrate Baryta	6	
Oxalate Soda	1	7
Dextrine	$1\frac{1}{2}$	1

EXHIBITION PUMPED STARS

Red for hand pump; not suitable for Shells

Nitrate Strontia	8	
Chlorate Potass;	4	10
Picric Acid	$1\frac{1}{2}$	$1\frac{1}{2}$
Shellac	$1\frac{1}{2}$	$\frac{3}{4}$
Fine Charcoal	$1\frac{1}{2}$	1
Dextrine	$\frac{1}{2}$	$\frac{1}{2}$
Carbonate Strontia		3

EXHIBITION GREEN STARS, PUMPED. (Not for shells)

Chlorate Baryta	12
Chlorate Potass	8
Calomel	6
Shellac	2
Picric Acid	2
Lampblack	$1\frac{1}{2}$
Dextrine	$\frac{1}{2}$

EXHIBITION BLUE STAR PUMPED

Chlorate Potass	48	18	7
Calomel	18	6	2
Black Oxid Copper	6		
Asphaltum	6		
Dextrine	1 $\frac{1}{2}$	1	$\frac{1}{2}$
Paris Green		4	3
Stearine		2	
Shellac			1

B O X S T A R SRED

Nitrate Strontia	3
Chlorate Potass	3
Shellac	1
Dextrine	$\frac{1}{4}$

GREEN

Nitrate Baryta	3
Chlorate Potass	4
Shellac	1
Dextrine	$\frac{1}{4}$

BLUE

Chlorate Potass	10
Copper Sulphate	3
Shellac	2
Calomel	2
Dextrine	$\frac{1}{2}$

Mix thoroughly the copper Sulph. Shellac, Calomel and dextrine, then add chlorate Potass; previously sifted by itself. This star is <sup>only</sup> suitable where it is to be used within a few days.

YELLOW

Chlorate Potassium	4
Oxalate Soda	2
Shellac	1
Dextrine	$\frac{1}{4}$

WHITE

Saltpeter	7
Sulphur	2
Powdered Metal Antimony	1 $\frac{1}{2}$
Dextrine	$\frac{1}{4}$

PURPLE

Chlorate Potass	18
Blk. Oxid Copper	1
Calomel	6
Nitrate Strontia	1
Dextrine	$\frac{1}{2}$

LAMP BLACK STAR.

Mealpowder	7
Lampblack	3
Black Antimony	1
Dextrine	$\frac{1}{4}$

Moisten with water; press into cakes and dry for 1 week and break into pieces about  $\frac{5}{8}$ " square.

YELLOW TWINKLERS.

Chlorate Potass	8
Lampblack	12
Stearine	$1\frac{1}{2}$
Saltpeter	1

Moisten with alcohol and shellac. Pump with hand pump.

STEEL STARS

Saltpeter	8	
Steel Filings	2	(Treated with parafine)
Mealpowder	1	
Charcoal	1	
Dextrine	$\frac{1}{4}$	
Moisten with water		

GOLDEN STREAMERS

Saltpeter	8	8	25
Oxalate Soda	4		
Sulphur	2		
Charcoal	$\frac{1}{2}$	4	7
Dextrine	$\frac{1}{2}$		1
Shellac			1
Lampblack		3	
Black Antimony		1	

SILVER SHOWER

Saltpeter	50	18
Sulphur	15	6
Red Arsenic	15	
Charcoal	10	$\frac{3}{4}$
Dextrine	3	
Black Antimony		6
Lampblack		1

Moisten with water



## ELECTRIC SPREADER STARS

The effect of these stars is quite surprising. A small pellet, no larger than a pea will spatter over an area of 15 feet when lighted. To make good electric spreader stars requires considerable care and judgement as dampening too much or too little greatly reduces their effectiveness.

Zinc Dust	36
Chlorate Potass	7½
Granulated Coal	6
Bichromate Potass	6
Dextrine	1

Mix thoroughly all but the charcoal and dampen until quite wet. Then add coal and mix again and pump with hand pump. Coal must be all coarse from which the fine has been sifted.

GRANITE STAR

Salt peter	14	6
Zinc Dust	40	8
Fine Charcoal	7	1
Sulphur	2½	4
Dextrine	1	1
Coarse Coal		2

For shells and rockets, this makes a very good substitute for Electric Spreader stars while being cheaper and safer to handle. It is moistened until quite wet, pressed into cakes 3/8" thick, cut into squares 3/8" each way, thoroughly dried and broken apart.

GOLD AND SILVER RAIN ( CUT STARS)

Meal Powder	16		4
Salt peter	10	1	1
Sulphur	10	1	
Fine Charcoal	4	1	2
Lampblack	2		
Red Arsenic	1		
Shellac	1		
Dextrine	1		
Nitrate lead		3	

Moisten with water and cut into squares ¼" each way.

MAGNESIUM STAR

Saltpeter	5
Magnesium Powder	2

Moisten with linseed oil. Owing to its high cost and instability magnesium has been almost entirely replaced by aluminum.

ALUMINUM STAR ( Box Stars Only)

Chlorate Potass	8	8
Potass Perchlorate	8	
Aluminum powd. medium	4	4
Shellac		1
Lycopodium	1	

Moisten with shellac solution and form into box stars  $\frac{5}{4}$ " long  $\frac{3}{4}$ " diam.

C O M E T S

These are large stars about  $1\frac{1}{2}$ " diam. fired from small mortars of paper. In their simplest form they are just large pumped stars. If the gun is 10 " long a piece of quickmatch 16" long is bared at one end about 1 " and at the other 5" Lay it alongside the comet star so that the 1" bared end can be bent over the bottom. Then paste a strip of paper 4" wide and 10" long and roll this around the star over the match with the same amount projecting on each side. When dry gather the upper extension around the match with a string and into the lower projection or bag put a half teaspoonful of coarse grain powder and secure with a string also. Now drop this in the gun and it is ready for use. Handsome effects are obtained by making half of the star of red star composition and the other half of streamer composition.

A more ambitious form of comet is illustrated in FIGURE 56, PLATE IV. This is rammed into a case as shown,

while the upper half, separated from the lower portion by a diaphragm of clay with small connecting orifice, is filled with small stars and blowing charge. At the end of its flight the stars are discharged with fine effect.

### A E R O L I T E S

These are made by placing a comet star at the bottom of a short gun with blowing charge but no match. Over the star is placed 2" of candle composition and over this 1" of bengal fire.

### COMET STAR COMPOSITION

Salt peter	6	
Meal powder	6	3
Sulphur	1	
Fine Charcoal	3	1
Powdered Antimony	3	1
Lampblack		2

### L A N C E W O R K

This is the division of pyrotechny which consists of reproducing with colored lights various designs, portraits, lettering etc., after the design is sketched on the floor as described under "Designing".

A number of frames are made, 5' wide and 10' long of light lumber  $\frac{1}{2}$ " x 2" for the outside strips and  $\frac{1}{2}$ " x 1" for the center ones, spaced 1 foot apart each way with a brace in the two corners as shown in FIGURE 57, PLATE IV. These are laid over the design on the floor and secured so that they do not shift until completed and the picture etc., transferred to the frames with bamboo for the curves and light strips of wood for the straight lines. FIGURE 58

When this has been completed frames should be numbered, beginning at left hand upper corner of first frame

and numbering each consecutively to assist in getting them in their proper places when erecting to be burned.

The frames are now ready for attaching the lances. This is done by driving a  $1\frac{1}{4}$ " wire nail to a depth of half an inch (b) at intervals of  $2\frac{1}{2}$ " in curves and 3" to 4" on straight lines all over the design. Be sure to see that there is always a nail at every point where two lines intersect. Now with a nipper cut off the heads of the nails, holding the nipper at an angle with the nail so that the place where the head has been cut off will have a sharp point instead of being cut off square across.

The frames are now ready for the lances. When it has been decided what colors are to be used for the various parts of the design, take a handful of lances of the desired color and dip their bottoms into glue to a depth of about  $1/8$ " and press one onto each of the nails until they are attached firmly to the cane or sticks forming design. (c)

FIGURE 58. PLATE IV.

When glue has hardened frame is ready for matching. Take a length of quickmatch and beginning at the upper end of frame pin it from one lance to another until entire frame is covered, following the outline of design as much as possible (f) FIGURE 58. When the end of a length of match is reached splice another to it by baring about 3" of the new length and slipping this bare end into the pipe of the preceding length; securing by tying and pasting joint.

Leave an end of match about 2' long projecting from the lower right hand corner of each frame so it can be connected to the one next to it when erecting. Also on one of

the bottom frames leave a leader 10 to 20 feet long, of match, to light piece by when it has been erected.

Now, with a three cornered awl make a hole  $\frac{1}{2}$ " deep through the match pipe and into the priming of each of the lances on the frame (d) FIGURE 58. Then take strips of tissue paper  $\frac{1}{2}$ " wide and 3" long; paste a number of them onto a light board and working along from lance to lance secure the match to top as shown at f FIGURE 58, PLATE IV. (b) Sometimes where it is desired to rush a job to be burned same day at point where it is made, the lances are secured by simply bending a pasted strip an inch wide over top of lance as shown at a b FIGURE 59.

The completed frames may now be crated into lots of four with  $\frac{1}{2}$ " x 2" strips arranged to hold them apart, for convenience in transportation.

### L A N C E S

These are small paper tubes from  $\frac{1}{4}$ " to  $\frac{3}{8}$ " diam. 2" to  $3\frac{1}{2}$ " long filled with composition burning different colors with a duration of one minute and used for producing the different designs used in fireworks exhibitions, such as portraits, mottoes, etc.. The cases are rolled as described on page 25 and rammed with funnel and rod, see page 39.

Some lance compositions are so light as to be difficult to ram. These should be slightly damped first. Blue lances made with paris green and white ones using realgar are frequently used without priming as they ignite very easily.

A good lance should burn clear for one minute, with-

out flaring or clogging up. All colors should burn of about the same duration. If a lance burns to one side it is often because the composition is not well mixed or because there is more paper on one side than on the other. They should have about three turns of paper all around.

### LANCE COMPOSITIONS

#### RED LANCES

Potass Chlorate	16	16
Strontia Nitrate	3	
Strontium Carbonate		3
Shellac	3	2
Lampblack	1/8	1

#### GREEN LANCES

Potassium Chlorate	7	16	16
Nitrate Baryta	7	4	6
Chlorate Baryta			6
Shellac	2	4	3
Calomel		3	3
Lampblack		1/8	2
Dextrine			1
Picric Acid			1

#### BLUE LANCES

Potassium Chlorate	20	16	12
Paris Green		5	
Blue Stone	6		
Copper Ammonium Sulfate			3
Shellac	4		1
Stearine		1 1/2	1 1/2
Calomel	4	3	3
Dextrine	1		

#### WHITE LANCES

Salt peter	9	14	5	8
Sulphur	1	4	2	2
Antimony Sulphide	2			
" metal Powd.		3	1	
Meal Powder			1	
Red Arsenic				1

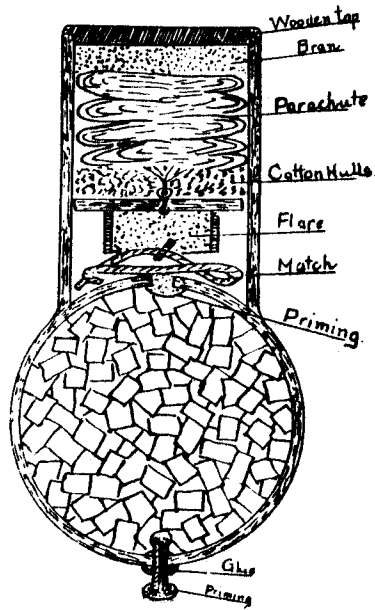

Parachute Shell. Fig. 64

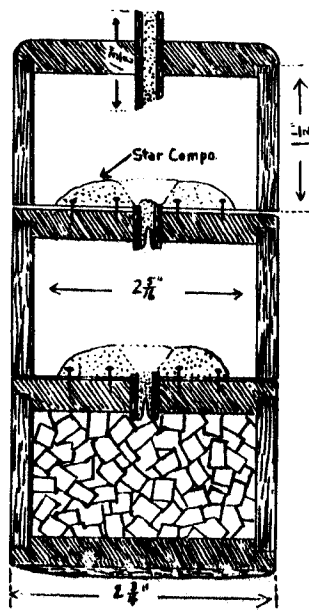

3 Break Shell. Fig. 65.

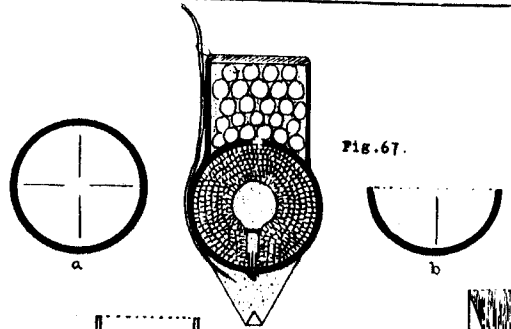

FIG. 67.

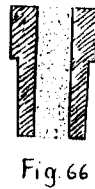
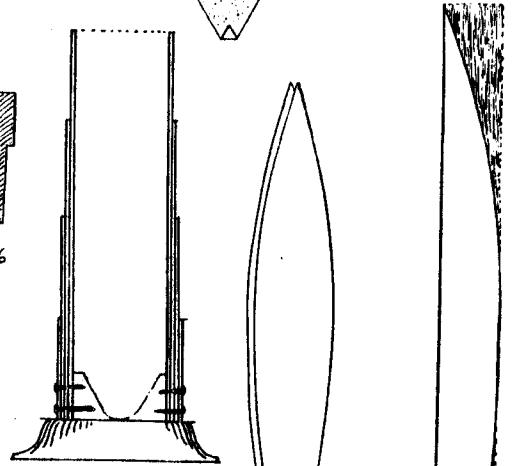

Fig. 66



MORTAR  
Fig. 68

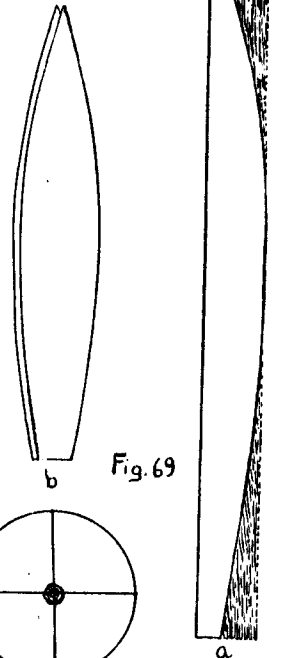
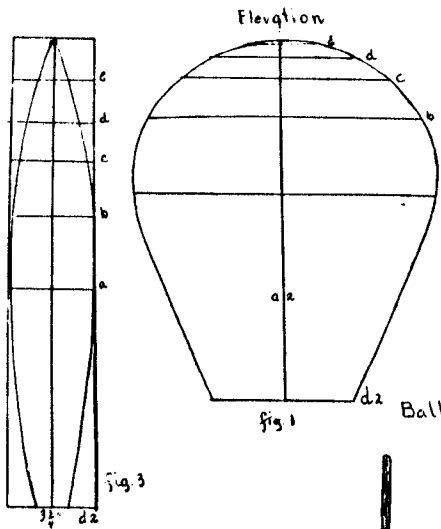

Fig. 69



Balloon Plan. Fig. 70

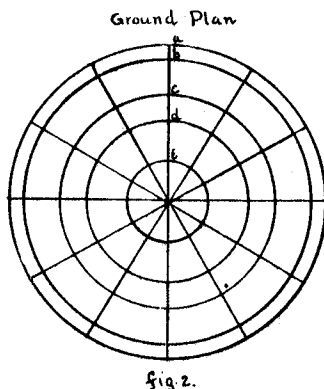

fig. 2.

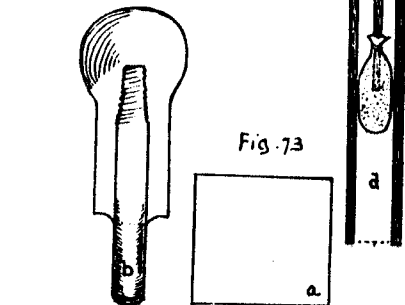
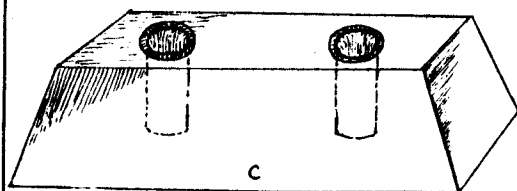

Fig. 73



Silver Torpedoes

Fig. 74 a



Fig. 74. b

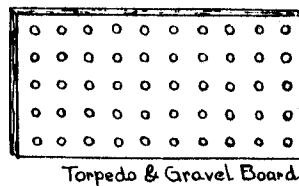

Torpedo & Gravel Board

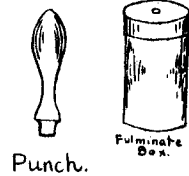

Punch.

Fulminate Box.

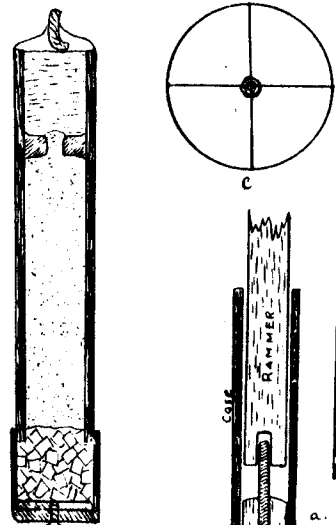

Fig. 71

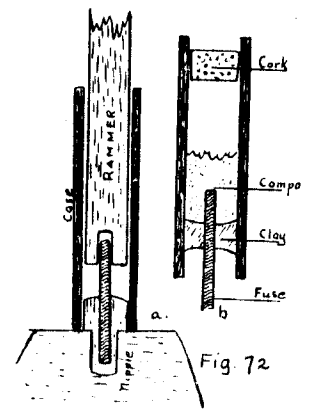

Fig. 72

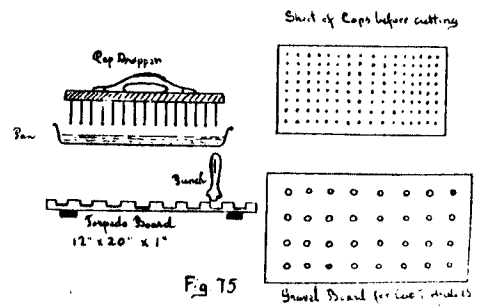

Fig. 75





YELLOW LANCES

Potassium Chlorate	16	4	4
Soda Oxalate	2	2	2
Shellac	3	1	1
Charcoal	$\frac{1}{8}$		
Nitrate Baryta			1

For amber and purple lances the recipes given for TORCHES May be used to advantage.

B O M B S H E L L S

These represent the highest development of the pyrotechnical art and require great patience and skill for their successful production. The most wonderful effects are produced by the Japanese while the finest color effects are made by the Europeans and Americans. Shells are made in several forms though round is the most popular. Cylindrical or canister shells however contain more stars etc. and in the more complicated effects it is sometimes necessary to attach a canister to the round shell to contain the parachute etc. FIGURE 64, PLATE V.

Shells are all fired from mortars, the smaller ones made of paper, up to about 3" diam. and the larger ones of wood, copper and iron. The smallest shells with which we have to deal are the

FLORAL SHELLS

	#1	#2	#3
Diam.	2-5/16	2-7/16	3-3/16
Height of Mortar	9"	11"	13"

The shells are made of hollow wooden balls which can be turned out by any wood turner. They are made in halves, usually with a rabbet to insure a close fit. Through one half,

drill a hole just the size to snugly fit a piece of ordinary blasting fuse,  $1\frac{1}{4}$ " long. Glue the fuse well on the inside as well as on the outside of the shell case. Now fill each half with stars to which add a teaspoonful of shell blowing powder, glue the edges of each half, clap them together and when dry paste a strip of paper around where the two halves join.

Prime the end of the fuse which should project through the shell about  $\frac{1}{4}$ ", bend a piece of naked match, about 8" long, around the shell so that the middle of it passes over the fuse, tacking the ends to other half of shell, so that they will stick over about 2". Set it now on the floral shell bottom as shown at FIGURE 60, PLATE IV. into which has been previously put an even teaspoonful (for the #1, larger sizes in proportion) of F grain powder, and secure with a strip of pasted paper. When dry, slip over the paper mortar, having previously well glued the bottom. Measure distance from top of mortar to top of shell inside and mark same on outside. Punch hole through same at this point; fit on a top and secure. Now take a roman candle a little longer than the mortar; punch a hole in its side near the bottom star; fit in a short piece of piped match near the other end; slip into hole in mortar, fasten candle to side with wire and floral shell is completed.

#### METEORIC SHELLS

These are made somewhat differently;  $\frac{1}{2}$ # to  $\frac{1}{3}$ # tin cans being substituted for wood shells. They are filled with stars, colored and Jap. and bursting powder in the same

manner as described above. A hole is punched through lid into which fuse is glued. A strip of paper about 3" wider than the length of can and long enough to roll around it six times is pasted all over, the filled can placed on it and rolled up something like a case is rolled. The  $1\frac{1}{2}$ " projecting over each end is now carefully pressed around the fuse on one side and the can bottom at the other. The shell is allowed to dry for a week before using. The end of fuse is trimmed and primed; a piece of piped match bared at each end is laid against its side, extending 1" beyond fuse at bottom of shell. A nosing 3" wide which secures the match in place is attached to shell and this when dry serves to contain the driving charge of a level teaspoonful of grain powder, after which it is gathered together and tied with twine. A dab of glue on bottom of bag suffices to hold it in bottom of mortar and it is ready for use. FIGURE 61, PLATE IV.

#### EXHIBITION BOMB SHELLS

The principal sizes of shells used for this purpose are 4", 6" and 10" diam. For round shells, after the cases have been made as described under "CASES" the upper halves are bored for the fuses. This may be done with a carpenters brace bit  $\frac{3}{4}$ ", boring from the inside. Fit the two halves accurately together; bind with a strip of glued cloth and over this two or three layers of paper strips laid on longitudinally, each strip overlapping the other before it by about  $\frac{1}{4}$ ". If each layer is made of a different length a better finish will be obtained.

When cases have been thoroughly dried fill them with

the desired stars through the fuse hole. When they will hold no more add blowing charge. The fuse should now be accurately fitted by cutting around it with a knife  $3/4$ " from the top and peeling off a layer or two of paper until it will just enter the hole which has been made in top of shell for it. Glue lower portion well and push into place until shoulder rests squarely against shell case.

Attach a cloth nosing to fuse; bare 1" at the end of a length of match and attach to bottom of shell by a #1 tack; lead match up to fuse, bend at right angles to permit of entry into nosing; cut the piping at point of entry and secure with strong cord. The remaining match also serves for lowering shell into mortar, up to 6" sizes. Larger shells must have a heavy cord passed around them for this purpose.

The necessary driving charge having been placed in a paper cone, this is attached to bottom of shell when same is completed.

The making of canister shells is so similar that their construction can be readily understood from the sketches (FIGURE 62, PLATE IV). The heads and bottoms are made of  $3/4$ " wood.

Another method of matching shells is to start at the fuse by baring a half inch at the end of a match pipe and pushing this into nosing. Bend match at right angles  $1/2$ " above nosing and pass under and entirely around shell, coming back again to nosing. Bend once more at right angles and insert bend alongside of where start was made first cutting through match pipe at point of insertion. Gather nosing closely

around match and tie tightly as possible. This method gives a somewhat better support to shell when lowering it into mortar. Where the match crosses bottom of shell and enters driving charge be sure to cut piping away for about half an inch.

Two and three break shells are made by lightly fastening together the desired number of very short canister shells with fuses not over  $\frac{1}{4}$ " long between them. The first shell has regular length fuse. The details can be better understood from drawings than from a description. See FIGURE 65, PLATE V.

PARACHUTE BEARING SHELLS are also shown in detail FIGURE 64, PLATE V.

#### SHELL FUSES

These are best made of hardware paper. Take a rod  $\frac{3}{8}$ " diam. for a 6" shell and a sheet of paper 6" wide. Paste it with thick paste all over one side and at once roll it up as tightly as possible until it has an outside diameter of  $\frac{7}{8}$ ". The length of sheet required is dependent on the thickness of the paper. When a number of these cases are rolled they must be dried in the shade until they are as hard as wood and rattle when struck together.

Take a rammer  $\frac{7}{16}$ " diam. a light mallet and some fuse composition made as follows:

Meal Powder	4
Saltpeter	2
Sulphur	1

Sift and mix three times. Rest a fuse case on a firm block, scoop in a little composition and tap it about 10 light

blows. Add more composition and ram again, repeating until fuse is filled. The composition in fuse must be as hard as possible when finished, otherwise it will blow through when used in a shell. The fuse may now be cut into the required lengths with a fine toothed hack saw. FIGURE 66, PLATE V.

<u>LENGTH OF FUSES</u>		<u>INSIDE DIAMETER OF FUSES</u>	
4" Shell	1 $\frac{1}{4}$ "	4" shell	5/16"
6" "	1-3/8"	6" "	3/8"
10" "	1 $\frac{1}{2}$ "	10" "	7/16"

In some cases a hole is drilled into the composition of the fuse on the end in the shell,  $\frac{1}{4}$ " deep, so the fire from same is thrown into the shell with more force. In this case allowance must be made when cutting lengths of fuse.

Shell Blowing Powder may be made of:

Meal Powder	1
Grain Powder	1
Saltpeter	3
Charcoal	1 $\frac{1}{2}$
Sulphur	1

The bursting and driving charge for shells is as follows:

<u>BURSTING CHARGE</u>		<u>DRIVING CHARGE</u>	
4" Shell	1-3/4 oz	4" shell	1 $\frac{1}{2}$ oz.
6" "	5 "	6" "	3 $\frac{1}{2}$ "
10" "	16 "	10" "	14 "

The driving charge should be coarse grain powder; cannon powder is best. An endless variety can be produced with shells some of which follow while the ingenuity of the pyrotechnist will suggest others as he progresses.

Solid color shells

Varigated Shells

Gold rain shells

Japanese or willow tree shells

Streamer shells

Aluminum shells

Conch shells \*

Chain shells

Repeating shells

Maroon or Salute shells

Day shells.

\* The Conch Shell consists of a 10" diam. shell packed with 3 ball roman cnadles made specially for this purpose. The cases of the candles are made of very strong paper so that they can be thin and no empty portion is left at top and bottom. In addition to the little roman candles, colored stars are added. This makes a very effective shell.

#### SHELL CONES

( For holding driving charge)

These are made by cutting out a round piece of good Kraft paper six to 12 inches diam. according to size of shell for which cone is intended. With a scissors make a cut from the edge to the center and twist it around so as to make a bag or cone of two thicknesses, pasting the edges where they meet. Put the driving charge into this and with a little paste attach it to the bottom of shell having previously cut the match piping where it crosses the bottom of shell, so that fire will strike driving charge when shell is lighted.

JAPANESE BOMBSHELLSDAY AND NIGHT

The Japanese have developed this form of pyrotechny to an almost incredible degree of beauty and originality. Some of their night shells are marvels of patience, ingenuity and skill.

DAY SHELLS consist of two kinds. First, those containing large figures of birds, animals etc. made of light tissue paper sewed together like a bag and open at the bottom with a row of small weights around the rim of the bottom. The figure is folded into a small compact pile and packed into a cylindrical shell case somewhat as parachutes are placed in rockets. When they are fired to a height of about 1000 feet the figure is expelled with a light charge and as it falls, the weights cause the bottom to unfold and the in-rushing air inflates it. Some of the shells are filled with parasols which, by an ingenious arrangement are made to open in the air. The second variety consist of colossal spiders made of smoke and vari-colored clouds which must be seen to be appreciated.

The night shells embrace some 50 to 75 different effects. Up to 40 years ago colors in night shells seem to have been unknown to the Japanese and all of their devices consisted of endless varieties of trailed stars, gold and silver rain, willow trees and bright work. The arrangement of the contents of these shells is shown in the accompanying sketches. FIGURE 67, PLATE V. The inside of the round shell case is scored as shown at (a) and (b) by cutting half way through the paper with a knife, in order to cause shell to burst even-



ly and throw the stars equally in all directions.

### M O R T A R S

Mortars for firing pyrotechnical bombshells are made in a variety of different ways. For shells up to 3" in diam. a mortar 12 to 15 inches high, made of a number of turns of good stout paper will serve for perhaps a hundred shots, especially if lined on the inside with a piece of tin or galvanized iron. If a bottom of oak or other hard wood is fitted to it and the barrel tightly wound with marlin, it will be perfectly safe, light and cheap.

For 4" diam. shells and upward mortars of copper tubes, shrunk, one over the other so that there are four thicknesses at the bottom, three for half the length two up to three-quarters of its barrel and one thickness for balance, with a ring at the top makes an ideal mortar.

Wrought iron tubes wound with galvanized wire and fitted with cast iron bottoms securely fastened in by machine bolts or rivets make very serviceable guns. The bottom should be conical on the inside to accommodate the powder bag of shell  
FIGURE 68, PLATE V.

The Japanese used long wooden mortars reinforced with iron bands. These were soaked in water before being used, to swell and tighten them. On account of their great length they would throw a shell to a great height with a small driving charge. They should always be buried for half their length in the ground when in use. With these mortars it was customary to pour the driving charge for shells, loosely into the mortar, drop the shell over it and fire by shaking a little dross from a port fire into the mortar. This method is dangerous and is not

Mortars with port holes on side of bottom, like the old style military mortars are sometimes used for day shells. The cartridge of shell is pierced with a priming rod and a piece of bare match inserted through port hole.

### B A L L O O N S

Secure some good tissue paper 20" x 30" (Foudrinier is best). Paste 2 sheets together on the 20" ends making a sheet 20" x 60". Split this lengthwise and get a sheet 10" x 60". Make 12 sheets of this size; lay one on top of another and double over the lot longitudinally so as to have pile 5" x 60". Now, with a scissors cut along the unfolded edge as shown in FIGURE 69 (a), PLATE V, removing the part shown as shaded. The exact line to cut may be determined by practice until the most satisfactory shape is found when an extra sheet of heavy paper should be cut and reserved as a pattern. Or, the pattern can be made according to instructions given under "Balloon Designing".

Unfold sheets cut as above and lay one on the table before you. On top of this lay another but about  $\frac{1}{2}$ " nearer to you thus leaving an uncovered edge of the under sheet exposed (b). Apply paste lightly to this edge and lap it over onto the upper sheet in this manner joining the two for their entire length. Make six pairs of sheets in this manner and then repeat the process with the double sheets until you have three sets of 4 sheets. Join these as before making the final closing joint likewise. If the top of balloon, where the points meet, is not well closed, paste a small round piece of paper

When balloon has dried make a ring of wire, bamboo or rattan for the bottom with cross wires to hold the inflator (c). For a balloon of the above size the ring should be about 15" diam. In balloons 10 feet or more in height a wire basket is sometimes woven into the center of the ring so that an extra inflator may be added just before releasing balloon when ready to rise.

### BALLOON INFLATORS

These are made in several ways. One consists of a ball of cotton wool which is saturated with alcohol or kerosene oil when balloon is to be inflated. A more convenient inflator may be made by impregnating a ball of excelsior with parafine and fastening it on top of cross wires of balloon ring. This has the advantage of being cleaner and requires nothing further than lighting when balloon is to be raised.

### DESIGNING BALLOONS

(FIGURE 70, PLATE V)

A balloon 5 ft. high when deflated may be made from 12 pieces of tissue paper cut out of sheets 10" wide and 60" long. To get the proper shape for cutting these sections draw a plan of the desired shape of balloon when finished, somewhat as shown in Figure 1. Then make a ground plan as shown in Figure 2. Quarter the elevation plan by the two lines a-1 a-2. The lines a-1 represent the balloon at its widest point in both plans. Line b in ground plan is obtained by measuring the length of line b in Figure 1 from central line a-2 to the edge of balloon and then taking the same distance from the

center of figure 2 and making a circle with a pair of compasses at this point. Lines c, d and e, are obtained in the same manner.

Now, to make the pattern as shown in Figure 3, draw a plan of one of the sheets from which balloon is to be cut using same scale as in figures 1 and 2. Divide it by a line through its center lengthwise and then locate lines a-1, b-1, c-1, d-1 and e-1, by measuring distance from bottom of balloon to each cross line on Figure 1, along one edge from d-2 to e. It now only remains to locate the points in Figure 3 for getting proper shape of pattern. To do this take a pair of dividers and measure length on line b-1 from central perpendicular line in Figure 2 to point where it intersects the next radial line to the right. Divide this distance equally to each side of central line of line b-1 in Figure 3. Do the same with lines c, d and e. On a large plan this may be more accurately done with a flexible rule but when using dividers as above a slight allowance must be made for the curvature of the lines on Figure 2. All that is necessary now is to draw an easy line from top to bottom of Figure 3, as shown. The bottom of 5' balloon should be about 15" diam. Dividing this by four will give approximately 3-3/4" for bottom of pattern.

#### FIREWORKS ATTACHMENTS FOR BALLOONS

These make a very pretty addition to a balloon ascension and may be designed in numerous ways as the ingenuity of the pyrotechnist will suggest. A typical attachment is shown in accompanying sketch FIGURE 71, PLATE V.

The lower portion of a gerb is filled with red fire

which burns until the balloon reaches the height of several hundred feet; then the gold rain effect of the gerb functions until the heading of stars, serpents etc., is discharged. A vertical wheel suspended from a wire and lighting when balloon is well up in the air makes a very interesting display.

### CANNON CRACKERS

In this item of pyrotechny the history of fireworks in general has been somewhat reversed. While many persons have lost limbs and life in the manufacture of roman candles, rockets etc. on a large scale, comparatively few serious accidents have occurred to those using them. On the other hand, though cannon crackers are one of the safest articles in the business to make, they have caused, during their short career, the loss of more hands, arms etc., to those firing them, than all other kinds of pyrotechnics combined.

The reason is simple. The composition of crackers is only explosive when confined or after the cracker is finished and the explosion of a finished cracker will not ignite others, as is the case with candles etc., where a spark will fire thousands at once. But when crackers are used by the inexperienced it is difficult to determine whether the fuse is lighted or not which often causes the cracker to explode in the hand, with disastrous results. Its bloody record has caused a number of states to legislate against its sale, in sizes larger than 3 to 4 inch. Until a fuse is invented that will be consumed as it burns, this piece of fireworks will be dangerous to handle.

The American Cannon Cracker is of comparatively

recent origin. Some forty years ago the first were placed on the market. Previously only Chinese Crackers were used but the greatly reduced cost and increased report soon caused them to supplant the imported article almost entirely in the larger sizes.

The cases for crackers are rolled similar to rocket cases except that paste is used only on the last turn at farthest end of sheet, the body of the case being rolled dry. By this means the cracker is more easily blown into small fragments and the danger of being struck by a large piece of hard case is avoided. The fuse used is the small red cotton untaped fuse made especially for this purpose though most any kind of blasting fuse may be used. A piece from  $1\frac{1}{2}$ " to 3" long is sufficient according to the length of the cracker. Most of it is made in Simsbury, Conn.

Various compositions are used, those containing Antimony giving the loudest report though being also most liable to spontaneous combustion, while those made with washed sulphur are much safer to handle but produce less noise. The cases should be filled about  $\frac{1}{3}$  full of composition to obtain the best results and compo. must be loose, not rammed. The addition of charcoal will increase the lightness of the composition and prevent its tendency to pack which lessens the report.

The ends of crackers are stopped in various ways. The best is by means of crimpers which pinch or mash the ends of the case around the fuse at one end and into a bunch or lump at the other. A dab of glue retains the ends in place. Another method is to close the fuse end with clay and the other

with a cork. The low grade of corks used for this purpose can be bought as cheaply as 12¢ M in the small sizes, which is less than the cost of plugs of any other sort.

To make crackers in this manner, roll the cases as directed. Make a brass nipple as shown (FIGURE 72, PLATE V) of the diameter of the cracker desired and about as high from top to shoulder. Drill a hole through the center somewhat larger than the fuse so it will pass easily into it. Also provide a rammer about 6" longer than the cracker and drill a hole into the lower end, somewhat larger than the fuse and ream or countersink it a little. After setting the nipple in a block, put a piece of fuse in it, slip a case on, put in enough slightly damped clay to occupy a half inch when rammed and with a few blows of a mallet set it firmly. You had best now remove the case and with a sharp knife split it open without breaking the clay and see if everything has been operating correctly, that is, if the proper amount of clay has been used and if the fuse projects sufficiently on the inside and has not been mashed into the clay as sometimes happens if the rammer has not been correctly made on the end which rams the clay while the fuse enters hole in same. Unless this has been well done the cracker will fail to explode. When these matters have been properly adjusted proceed with ramming clay in another case and scoop in enough composition (any one from list to follow) to fill case about one third. Then take a cork that will fit pretty snugly, dip the small end in liquid fish glue and force it in open end of cracker. It is now completed and may be removed from nipple. If too much composition is used the report is weakened; a full case will hardly explode

at all.

When crackers are made on a large scale, a block of six dozen nipples is used, six wide and 12 lengthwise, same as for roman candles. The clay and composition can be dropped into lot simultaneously by the use of shifting boards as shown under candle machine. Some manufacturers prefer to use a long nipple and short rammer, reversing the manner of ramming as the cracker is rammed from the fuse end instead of from the cork end. By this means the danger of mashing the fuse into the clay is avoided as the nipple on the inside protects it. But only the clay can be filled into them all at once by this method, as, the composition being loaded from the other end, they must be removed from the spindles before this can be accomplished.

The following are the standard sizes.

<u>NUMBERS</u>	<u>LENGTH</u>	<u>BORE</u>	<u>NO. IN BOX</u>	<u>BOXES IN CASE</u>
1 Salutes	2"	5/16"	100	20
2 "	3"	"	50	25
3 "	3½"	3/8"	15	100
4 Crackers	4"	7/16"	30	20
5 "	5"	1/2"	20	20
7 "	6½"	5/8"	10	20
9 "	8"	3/4"	5	20
10 "	9½"	7/8"	3	20
12 "	10½"	1"	2	20
15 "	13"	1¼"		25 in case



CANNON CRACKER COMPOSITION

Potassium Chlorate	60	6	6
Washed Sulphur	23	3	2
Sulphuret Antimony	5		
Metalic Antimony			1
Charcoal		1	
Saltpeter	12		

If unwashed sulphur is used the report will be considerably louder but the danger is greater. Of the above mixings, the last is about the safest that can be made. The first gives the loudest report. Great care must be exercised in mixing the composition for cannon crackers. Each ingredient should be sifted separately and then mixed in a tub with the fingers, preferably gloved, being careful not to scratch the bottom of tub with the nails.

FLASH CRACKERS

This interesting addition to pyrotechny is one of the results of the advent of aluminum. The following composition may be used both for flash crackers and maroon shells.

	#1	#2
Perchlorate Potass		9 lbs. 6 oz.
Potassium Chlorate	6	
Washed Sulphur	3	4 " 11 "
Pyro Aluminum	1	9 " 6 "
Charcoal	1	

Mix thoroughly the sulphur, coal and aluminum; then add the chlorate potass; previously sifted by itself; mixing by rolling the ingredients back and forth on a piece of paper and

avoiding friction of any kind.

Prepare a block c FIGURE 73, PLATE V, by boring several holes as shown,  $7/16$ " diameter and 1" deep. Also a nipple  $3/8$ " diam, fitted into a handle b and some pieces of strong light paper  $2\frac{1}{2}$ " square a. Take a piece of paper in one hand and with the nipple in the other, form the paper around it so as to form a little cup which is now inserted in the hole in block, pressing down until the flange of the nipple spreads the upper edges of the paper. Remove the nipple and put into the paper cup enough composition to half fill it. Insert a piece of match 3" long. Draw the paper around the match and secure tightly with two half hitches of linen twine. Remove from block; smear a little gum on one side and push into a cracker case (d)  $\frac{1}{2}$ " diam. and 3" long. It is not necessary to close the ends of flash crackers as the report is just as loud when they are left open.

Composition #2 is much the safest and should be used by any but those very familiar with this class of work. \*

### TORPEDOES

By this name is understood the toy torpedoes used by children, which detonate when thrown on the ground. I believe that these were first made by the French under the name of "Pois fulminant" (mad peas), but the so called Jap. or cap torpedoes, which constitute far the largest part of those used today, as near as I can find out, are an American invention.

\* Sulphur in this formula need not be washed.

SILVER TORPEDOES

## FULMINATE OF SILVER

The fulminate is prepared by taking 8 ozs. of C. P. Nitric acid (42%) and adding gradually, stirring constantly with a glass rod, 2 ozs. water. Into this put a silver dollar or 1 oz. of bar silver. Warm slightly until a brisk reaction takes place. Then the silver is completely dissolved allow to cool for three minutes. Then add 16 ozs. pure alcohol. Add it all at once and quickly and be sure that the vessel containing the solution of silver is at least four times as large as the amount contained for a violent effervescence will take place. After it subsides add three ounces more alcohol. Let stand for a quarter to one half hour when a white crystalline precipitate will be formed on the bottom of vessel which is the fulminate and may be collected on a filter and dried in a shady place. A candy jar may be used for making the fulminate but a glass beaker is far preferable.

The utmost care must be exercised in handling the dry powder as the slightest concussion will explode the entire lot with terrific violence. A wooden spoon should be used for removing it from the filter and it should be handled as little as possible and in the smallest practicable quantities. Procure a round paper box from a drug store, one inch in diameter and 3" high. Make a small hole  $\frac{1}{16}$ " in diam. through the cover and fill it about half full of the dry fulminate. Now take a board 10" wide and 20" long,  $\frac{7}{8}$ " thick and with a  $\frac{3}{4}$ " bit bore 50 holes through it, (5 rows, 10 to a row). This is the torpedo board. Then take a similar board and with a  $\frac{1}{2}$ " bit

bore the same number of holes in the same position, into it but not quite through. This is the gravel board. A punch will now be required as shown in FIGURE 74, PLATE V. The nipple being  $5/8$ " diam. and  $3/4$ " long.

Get some of the best grade tissue paper and cut it into pieces 2" square. Take a bunch of them in the left hand. Place one over each hole in the torpedo board, at the same time forcing it in the hole with the puncher so as to make a little bag. When the board is filled with paper dip the gravel board into a box filled with gravel, tilting the board so the surplus will run off and the holes will be just filled. Then reverse the board containing the papers and place it over the board of gravel. Hold tightly together and turn both boards together upside down and the gravel will be emptied in to the torpedo board all at once. Remove the now empty gravel board and with the fulminate box shake a little of the powder into each little bag of gravel just as you would shake salt from a salt-cellar. Only a very little is required. Now dip the tips of the thumb and forefinger into paste and with the finger tips of both hands gather up the edges of the paper, bunch them together and by giving a few twists the torpedo is finished. Care must be taken not to twist too tightly as the torpedo will be likely to explode in the fingers.

#### JAPANESE OR CAP TORPEDOES

These, while considerably safer than the silver torpedoes to make, and handle, require to be struck with much more force in order to make them explode. First we must proceed to make the caps. FIGURE 75, PLATE V.

There are required a pan 2" deep, 8" wide and 10" long, a number of pieces of blanket 12" square which must be well dampened before using, and a cap dropper made by driving 150 8 penny nails, for one inch of their length into a wooden block  $1\frac{1}{2}$ " thick and fitted with a handle as shown in illustration. The heads of the nails should be well levelled up so that every one touches when dropper stands on a flat surface. Also cut a lot of pieces of poster paper 6" x 8" and place them in two piles on the work table. They are for dropping the caps onto. The cap composition is made as follows:

<u>NUMBER ONE</u>		<u>NUMBER TWO</u>	
Potassium Chlorate	5 ozs.		
Sulphur	$\frac{1}{4}$ "	Amorphous Phosphorus	
Chalk	$\frac{1}{4}$ "		2 ozs.

Sift separately the ingredients of No. 1, mix thoroughly and moisten in a bowl with water until of the consistency of porridge. In another bowl moisten the 2 ozs Amorphous Phosphorus to the same consistency. Then stir the phosphorus into the bowl containing the other ingredients, with a spoon. Then thoroughly mixed pour into the pan previously mentioned.

Take the dropper by the handle and dip it into the pan of composition, remove it and print it lightly into the top sheet of one of the piles of poster. With a wide brush paste the top sheet on the other pile, all over on one side with thin paste to which a little dextrine has been added and reverse it onto the sheet that has just had the caps dropped on it. Now remove the finished sheet of caps to one of the damp blankets and repeat operation, placing a piece of blanket

between each sheet of caps until all the composition is used up after which place a light board on top of the pile of alternate caps and blankets, and on this, a weight allowing it to remain for about an hour, after which remove the blankets and place the pile of caps in a tight box where they cannot become dry.

Now fill the torpedo board as before directed only using a somewhat smaller gravel board. Take out a few sheets of caps and with a long pair of scissors cut between each row of caps each way so as to separate them. Now place one squarely on top of the gravel in each torpedo and taking a handful of gravel, drop a little on top of each cap. They are now ready to be twisted as described for silver torpedoes. When a number have been finished they should be packed in sawdust or rice shells and removed from the workroom. Too many should not be allowed to accumulate in a pile, for when dry, the explosion of one will sometimes fire the entire lot and the flying stones often cause serious injury. Be sure never to allow the caps to become dry while making the torpedoes, or in the storage box.

In making caps, when a batch has been completed, be very careful to wipe up thoroughly every drop or speck that may be spilled, and wash well the pan and dropper etc. as well as the table, shears and brush used and throw away the washings where they will run off.

Japanese torpedoes do not keep much over a year as the phosphorus decomposes and after awhile disappears entirely from the cap. Following are the principal sizes and packings of torpedoes:

SILVER TORPEDOES

<u>NAME</u>	<u>SIZE PAPER</u>	<u>HOLE TORP BOARD</u>	<u>NO. IN BOX</u>	<u>BXS IN CASE</u>
Electric	1-5/8" sq.	1/2"	25	50
Giant	3" Square	1"	10	50

JAPANESE TORPEDOES

Am. Extras	1-5/8"	1/2"	25	100
Japanese	3"	1"	5	200
Japanese	3"	1"	10	100
Japanese	3"	1"	25	40
Cat Scat	5 1/8"	1 1/8"	10	40
Cannon	7"	2"	10	25

RAILROAD TORPEDOES

These consist of a 1 oz. tin ointment can containing a mixture similar to that used in paper caps. A strip of lead is soldered to bottom of box so it can be easily attached to rail by bending strip around top of rail, and fires when engine runs over it. FIGURE 74 b.

PAPER CAPS

These are made similar to those described under Japanese Torpedoes with such variations of detail as are necessary to their special requirements. They are, of course, punched out by machinery a sheet at a time.

WHISTLING FIREWORKS

The peculiar property of Potass: Picrate to whistle while burning has been known for quite a long time and has been made use of for producing the amusing whistling fireworks. To make this article:

Dissolve 1 lb. of picric acid in the least possible quantity of boiling water, in a porcelain lined receptacle; add  $\frac{1}{2}$  lb. potass; Carbonate, little by little, stirring continuously. Then add 1 lb. Powd. Saltpeter. Stir thoroughly, allow to stand for an hour and remove to a heavy piece of filter paper placed in a glass funnel, where it can drain. When dry crush to fine powder with a wooden roller. Very small quantities should be handled at a time as an explosion will cause disastrous results. The dry powder may be rammed into tubes from  $\frac{1}{2}$ " to  $\frac{3}{4}$ " diam. and will produce the whistling sound when burned. Bamboe tubes are most effective.

Owing to the ease with which Potass Picrate detonates whistles cannot be used in shells but small tubes  $\frac{1}{2}$ " diam. and  $2\frac{1}{2}$ " long when charged with the above composition may be placed in the heads of rockets or fastened to the outside and arranged to burn as the rocket is ascending. Attached to wheels they are quite amusing, but the most effective use for them is when a series of six or eight ranging in size from  $\frac{1}{2}$ " diam. to  $\frac{3}{4}$ " diam. are set side by side like a Pandean Pipe and burned simultaneously.

#### SON OF A GUN

( Spit Devil--- Devil on the Walk)

This amusing little piece of fireworks consists of a disc about one inch or more in diam. which, when scratched on the pavement gives off a continuous series of little explosions, burning from one half to three quarters of a minute. On account of somewhat resembling candy lozenges a number of fatal accidents have occurred by small children



swallowing them. For this reason their sale has been forbidden in some sections. They are made as follows: FIGURE 76, Plate VI.

Secure a number of boards of  $7/8$ " material and bore holes into them  $1/4$ " deep and  $1 1/2$ " diam. somewhat as shown at a. Turn up a puncher like b which will work easily in the holes. Cut some red Foudrinier tissue paper into circular pieces  $2 1/2$ " diam. Lay them over the holes in board and punch in. Pour into these the composition given below and fold over the edges of the paper as in c. Permit to set and when hardened they may be removed and thoroughly dried when they will be ready for use.

#### SON OF A GUN COMPOSITION

Mix 5 kilograms of powdered gum Arabic with 5 litres of water, adding water gradually with constant stirring. Then add  $1 1/2$  kg. Magnesium carbonate. Place this in a water bath with a thermometer arranged so that temperature can be carefully observed and heat to  $50^{\circ}$  C. After which add a mixture of one kg. white phosphorus and stir until entirely melted. Continue stirring while cooling to  $25^{\circ}$  C. After which add a mixture of  $2 1/2$  kg. Red Ochre and 3 kg. Potass; Chlorate and stir until a perfectly smooth product results after which it may be poured into the paper molds as above. Great care must be used to prevent accidents in all mixtures containing phosphorus and chlorate of Potass.

#### PHARAOHS SERPENTS EGGS

This remarkable substance consists of small pellets of Sulphocyanide of Mercury which has the remarkable property

of swelling 25 to 50 times its original size when lighted, producing a long snake like ash. To prepare, make a concentrated solution of Mercuric chloride and add little by little a solution of potassium sulphocyanide, stirring constantly. A greyish precipitate will be formed and when the last drop of sulphocyanide added no longer produces cloudiness permit the mixture to settle. Drain off as much as possible of the clear supernant liquid, remove precipitate to a paper filter placed in a glass funnel and wash slightly. When thoroughly dry reduce to a fine powder. Then ready to make the "eggs" moisten very sparingly with a weak solution of Gum Arabic and form into small cones with the appliance FIGURE 77, PLATE VI.

There is also a large black snake on the market under the name of "Magic Serpents" containing asphaltum, potass; bichromate and other things but its formula is not known to the author.

#### SNAKE NESTS

(Snake in the grass)

These consist of small cones of tinfoil containing a preparation which, when ignited, produce a grass green pile of ash from which presently emerges a "Pharaohs Serpent"

Cut some tin foil into circles  $1\frac{1}{2}$ " diam. Cut these again from the periphery to the center as shown at a FIGURE 78, PLATE VI. Fold them around the former(b) so as to make little cones and insert into block(c) filling them with the following composition:

Salt peter	1
Ammonium bichromate	2
Dextrine	1

Son of a Sun tools.

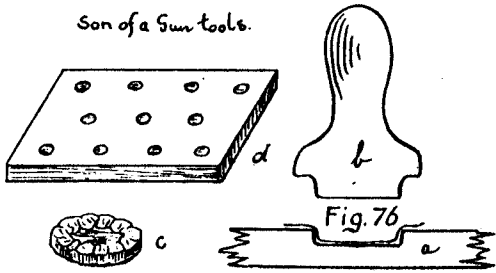

Fig. 76

FIG. 77

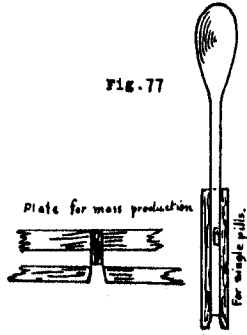

Plate for mass production

Pharaoh Soapcut Egg former.



Fig. 80

Fig. 78.

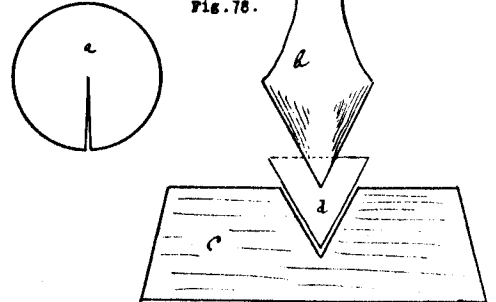

Snake Nest tools.

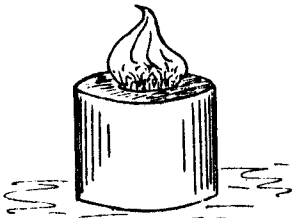

Fig. 79

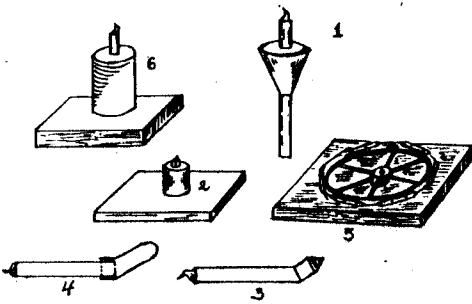

Fig. 81

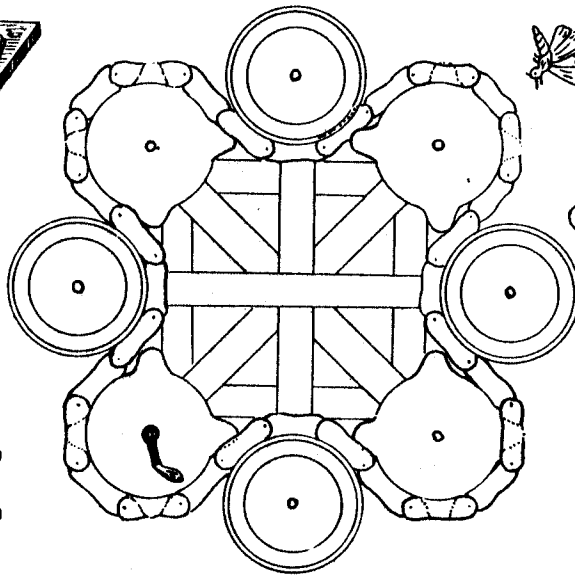
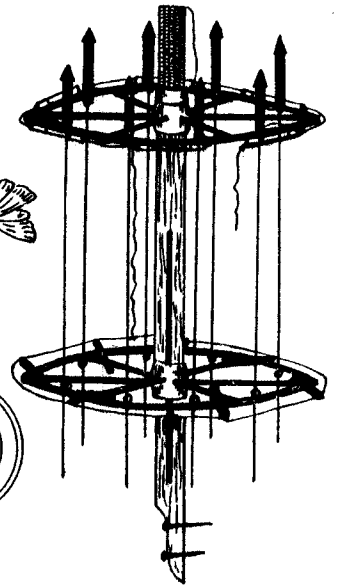
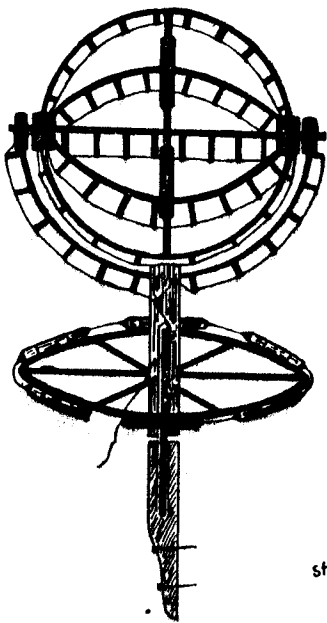

Fig. 82



Rocket Wheel.

Fig. 83.



Revolving Globe.

Fig. 84.

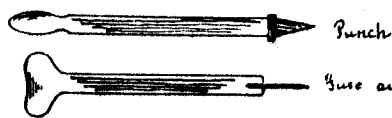
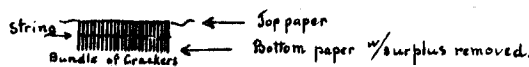
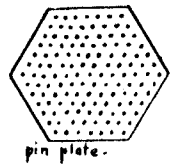
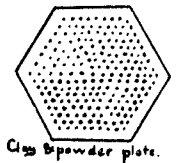
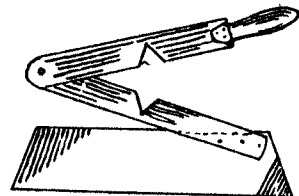

Fig. 85.





When quite full up to the edge of the block, press into center a pellet of Pharaoh's Serpent powder. Fold over the edges to the center and remove from block. To use, light at top of cone.

### COLORED FLAMES

These are made by dissolving various substances in alcohol. A copper can filled with cotton is impregnated with the alcoholic solution. It is lighted by a tuft of cotton left protruding from the opening, FIGURE 79, PLATE VI.

For Green Flame	use Boric Acid.
Red	Strontium or Lithum Chloride
Yellow	Sodium Chloride
Blue	Copper sulfate or Caseium Carbonate

Before lighting sprinkle a little of the powdered chemical over the cotton where it projects from the can.

### COLORED FIRE STICKS

These consist of thin wooden sticks similar to applicators used by physicians for applying iodine etc. to affected parts. They are dipped for half their length into colored fire compositions in a more or less liquid state.

One method is to melt one part of gum shellac in an iron pot, stir in five parts of very finely powdered strontium nitrate. To keep this sufficiently liquid it must be kept quite hot by the use of a steam kettle. This is for red sticks. Another method is to dissolve the shellac in alcohol and adding the strontium. The proper consistency of the mixture can be easily regulated by using more or less alcohol as required. When the sticks are dried they are ready for use.

Green is not so successfully made, barium nitrate/being substituted for strontium. A little lampblack improves the burning but detracts from the color, especially the green. The sticks are pushed into a groove in the bar as shown, FIGURE 80, PLATE VI. for drying.

#### RUBY AND EMERALD SHOTER STICKS

These are much more effective and are made in much the same manner as above, using following composition:

Strontium nitrate	6
Coarse Aluminum	6
Potassium Perchlorate	2
Shellac	1

Dissolve shellac in alcohol and add other ingredients, previously well mixed. Stir thoroughly to a consistency of thick glue and dip sticks previously arranged in holder so they may be placed in drying rack.

#### FOR GREEN USE:

Aluminum powder, coarse	6
Barium Chlorate	4
Shellac	3/4
Alcohol q.s.	

The Japanese make a similar article of twisted paper but this requires a great deal of practice and patience to learn, almost unattainable by western races.

#### S P A R K L E R S

These are made in a general way like the above but in effect they throw off a shower of beautiful sparks so distinctive to Steel Filings. The following composition may be

used:

141

Lamp black	36	
Powdered charcoal		25
Steel Filings	30	50
Aluminum powder	15	
Gum Arabic	6	5
Saltpeter	5	15
Sulphur	2	6

The Gum Arabic is worked up with water into the consistency of mucilage, the other items, except the steel filings are stirred in. The steel, protected by paraffin as explained is finally added. After the mixture is worked up to the consistency of porridge the sticks are dipped as for Colored Fire Sticks.

#### WATER FIREWORKS

These consist mainly of five or six varieties as follows: FIGURE 81, PLATE VI.

No. 1 Floating gerb or roman candle. A cone shaped piece of light wood is bored with a hole of suitable size to take the gerb or candle as shown. In order to secure an upright position with roman candles it is sometimes necessary to place a charge of iron filings in the bottom of a case.

No. 2. Floating Tableau Lights are merely a colored pot of suitable size placed on a board.

No. 3. Diving Devils. A sharp gerb is fitted with a hollow head set at an angle with the case. Careful adjustment must be made so as to insure the floating of the gerb which will cause it to dive into and come up out of the water properly.

This is perhaps the most amusing piece of water fireworks as well as the one calling for the most careful work. The tip of float must be weighted so as to cause it to dive and yet be buoyant enough to make it rise again.

No. 4. Fish are made similar to the Diving Devil except that not so much adjustment is necessary as they only run around on top of the water.

No. 5. Water Wheels are an ordinary Vertical Wheel set on a board float as shown.

The Fish and Devils should be heavily coated with paraffin when finished; even the nosing of the match should be protected in this manner and water-proof fuse, properly primed, used for lighting.

Water fireworks are only practical on quiet ponds and small lakes and are usually fired from a skiff. Great care should be used to protect the supply in boat from sparks of those burning, in order to prevent accidents to the operator.

#6 is a Floating Mine.

#### SMOKE AND SPARK POTS

These are used mostly in the large spectacular pyrotechnical pictures featuring volcanos etc. such as " The Last Days of Pompeii " Burning of Rome " etc. They consist of short mine cases about 4" to 6" in diam. and 6" to 12" long.

The compositions are:

#### SPARK POT

Meal powder	2
Fine Charcoal	1
Sawdust	1



<u>SMOKE POT</u>		or	
Strontium Nitrate	10	Saltpeter	4
Sulphur	6	Lampblack	1
Whiting (Chalk)	4	Charcoal	1
Fine Charcoal	3/4	Red Arsenic	1
Dextrine	3/4	Rosin	1

#### SMOKE SCREEN

While these are really no part of the pyrotechnical art they do come under the heading of Military Pyrotechnics. They consist of a fine stream of Titanium tetrachloride which is sprayed from an airplane at a suitable height and which in falling produces the dense smoke intended to screen what is behind it. The liquid is projected backward from the plane at the same rate as the planes movement through the air so that the droplets fall perpendicularly.

#### SMOKE CLOUDS

These are for use in day fireworks displays and consist of small shells filled with various colored powder such as vermilion for red clouds, ultramarine for blue, yellow ochre for yellow and chrome green for green clouds. The bursting charge is put up in a little paper bag which is fastened to the end of the fuse on the inside of the shell. The colored powder is packed as tightly as possible in each half shell the two halves slapped together and a strip of glued canvas passed around the joint to hold them.

#### SMOKE STARS

Such as are used for producing the enormous spider effects of the Jap. Day Shells are box stars, closed at the

bottom while the top has two strips of heavy paper pasted across it so as to leave only a small portion of the contents exposed. This end is primed to make it take fire easily and the cross strips restrict the opening so that the composition smokes instead of taking fire and flaming while burning.

SMOKE STAR COMPOSITION

Mealpowder	1
Sulphur	1
Saltpeter	1
Antimony Sulph	1

SMOKE GERB FOR HANGING FROM PARACHUTE ( YELLOW )

Mealpowder	1
Black Antimony	1
Red Arsenic	1
Sulphur	1
Saltpeter	1

RED SMOKE

Potass: Chlorate	1
Lactose	1
Paranitraniline	3

GREEN SMOKE

Potass: Chlorate	33
Lactose	26
Auremine	15
Indigo (Synthetic)	26

BLUE SMOKE

Potass: Chlorate	7
Lactose	5
Indigo (Synthetic)	8

P A R T   I V.EXHIBITIONFIREWORKSSNAKE AND BUTTERFLY

This ingenious piece of fireworks is believed to have been devised by the Brock Fireworks Co. of Surrey, England, and created quite a sensation at the Crystal Palace when first shown about forty years ago. It consists of a snake squirming around in the air after a butterfly which manages however to evade it.

The framework consists of an endless chain of wooden links 4" x 8" bolted together and running on four sprockets and four idlers of a suitable size as shown in FIGURE 82, PLATE VI. When mounted, a crank is attached to one of the sprockets by which the whole is operated. The snake and butterfly are made of lancework which is attached to the chain.

ROCKET WHEEL

This is a very old, yet always attractive device. It consists of two wheels three feet in diameter, attached to opposite ends of an axle, arranged to revolve horizontally on a spindle as shown. The rockets pass through screw eyes along the rim of the wheel, and are matched to fire at intervals as the wheel revolves by being connected to successive

drivers. On the top is a battery of roman candles. The top wheel is fitted with ordinary drivers containing steel filings and matched to burn two at a time, one each on opposite sides. The lower wheel is fitted with aluminum gerbs all to burn at once with the last two drivers of the top wheel. The latter are set at an angle with the axis of rotation so as to give a wider spread of fire. The battery of candles starts with second pair of drivers of top wheel. FIGURE 83, PLATE VI.

#### REVOLVING GLOBE

This simple yet baffling and always interesting device is constructed as shown in FIGURE 84, PLATE VI. The frame may be secured in different sizes, all ready for lances etc. from manufacturers of fireworks wheels in North Weare, N. H. or it may be constructed by the pyrotechnist himself according to suggestions given in sketch.

When the piece is turning, the globe appears to be revolving first in one, then in the other direction in a most amusing manner.

A P P E N D I X

CHINESE FIRE CRACKERSFIGURE 85, PLATE VI.

As far as is known to the writer there has never been given in English a detailed description of this interesting little article of pyrotechnics of which there are undoubtedly more made than of any other piece of fireworks. The ingenuity of its production in the unbelievably large quantities that they are made is only equalled by the many other unusual things done by this most patient and painstaking race.

The tubes or firecracker cases are  $1\frac{3}{4}$ " long,  $\frac{1}{4}$ " outside diameter and have a bore of  $\frac{5}{32}$ ". They are rolled of a grade of paper unknown in this country; perhaps the lowest grade of paper made, unsized and quite irregular in character; a sort of coarse blotting paper. A small amount of gum water or rice paste is used as a binder and the case is finished with one turn of very thin red, green or yellow paper. They are rolled in lengths of one to two feet and then cut to the required size.

Now a block is prepared for gathering about 1000 of the tubes into a hexagon shaped bundle, as follows: A piece of hard wood about 1" thick and cut into a hexagon, each side of which is 5" wide is provided with pointed wood or metal pins  $\frac{3}{4}$ " long and  $\frac{5}{32}$ " diam. set into the wood base so that the above amount projects, and exactly  $\frac{1}{4}$ " apart. They are also arranged in a hexagon with sides 4 inches wide. A tube is now slipped over each pin until the entire block is filled, having previously provided a wood frame the same size as the

outside of the block one half inch thick and having an inside diameter slightly greater than the assembled tubes so as to be able to slip snugly around them. This is slipped up and down a few times to shape the bundle nicely and a string tied around it to further secure same.

A piece of white paper is now pasted over the top of the bundle. When dry it is removed from the form and a piece of paper pasted on the other side when it is dried again. The under side is moistened at the edges and the surplus paper neatly rubbed off. When again dry the upper side is moistened all over and the paper over the top of each cracker is pierced with a punch or round pointed stick so that they may be charged with the necessary powder and clay. Some operators hold several sticks in between their fingers at one time so as to be able to punch several holes simultaneously.

A wooden board about one inch wider all around than the bundle of crackers and  $\frac{1}{4}$ " inch thick with  $\frac{1}{8}$ " holes bored through it, corresponding exactly in position with the crackers in the bundle, is now laid on a smooth board, covered with finely powdered clay which is pressed into the holes in it, with the hand, until it is firm enough not to fall out when the piece is lifted. The surplus is brushed off and it is placed over the bundle of crackers so that the clay filled holes are exactly over the openings in the tubes. A slight blow is usually sufficient to cause the clay to fall into the crackers. Any not falling out is pushed out with a stick. The bundle is jarred slightly against the table to make the clay settle. A similar operation is now performed with a thicker board con-

taining slightly larger holes capable of holding the powder charge after which the clay board is used once more as described above.

The top layer of paper is now moistened so that it may be entirely removed and the clay which has become slightly moistened as well, is gently pushed down with a suitable rammer. It is then dried in the sun. The bottom end is now carefully dipped into water, turned bottom up and the paper removed from this side also, the clay pushed down and pierced with an awl for the purpose of inserting the match or fuse. This is however not done until the crackers have been again dried in the sun. After the fuses are inserted the ends of the crackers are pinched around it, about 1/8" from the end, by a crimper or two blunt knives hinged together at one end and have a V shaped notch cut out of the center of each blade, so that when the two notches approach from opposite sides they pinch the cracker together and cause the fuse to be held in place. When they are now finally dried for the last time they are platted together so as to form the packs of commerce. The platting and wrapping of the packs is such a dexterous performance that it is useless to try to describe it as it is only acquired by many years of succeeding generations doing the same thing.

The following formulas are in use for making the composition used in chinese crackers and flash crackers:



CHINESE FIRE CRACKERS

Saltpeter	50		45
Sulphur	25		18
Charcoal	25		25
Chlorate Potass			8
Sand			4

FLASH CRACKERS

Saltpeter	50		
Sulphur	30	25	30
Aluminum Powder fine	20	25	40
Per-Chlorate Potass		50	30

A very important as well as extremely difficult part of the Chinese cracker to make is the fuse. Very tender and skilled fingers are required to produce this insignificant looking yet most requisite adjunct. A thin strip of the finest Chinese tissue paper, about 3/4" wide and 14" long is laid on a smooth damp board; a little stream of powder is poured down its center from a hollow bamboo stick and with the tips of soft skinned fingers which seem to have an attraction for the paper and placed against the right hand lower corner, a rolling motion in the general direction of the upper left hand corner causes the paper to roll up into a twine like fuse. The slightest touch of paste secured the end and prevents unrolling. When dry it is cut into the required lengths and is ready for use.

NOTE: The information upon which the foregoing article was written has been supplied by Mr. Ip Lan Chuen, Manager of the Kwong Man Loong Fireworks Co. of Hong Kong, China.

I N D E X

152

Aerolites	
Aluminum	109
Ammonium chloride	12
Antimony, metallic	13
"    red and black	10
Asphaltum, gum	11
Arsenic, red	7
Balloons, designing	11
"    constructing	123
"    fireworks attachments	122
"    inflators	124
Barium, nitrate	123
"    chlorate	9
Bengolas	9
Blue lights	64
Batteries	65
Bombette fountains	73
Bombshells, round	73
"    canister	113
"    Japanese	116
Boris acid	120
Bouquets	9
Calomel	83
Cascades	13
Cases, rolling	95
"    candle	25
"    cascade	28
"    drying	94
"    gerb	35
"    driving	30
"    lance	97
"    mine & floral shell	27
"    saucisson	32
"    serpent	90
"    shell	89
"    rocket	32
"    torch	30
Charcoal	61
Colored fires	6
"    smokeless	54
"    sticks	56
Clay	139
Comets	15
Copper, carbonate	108
"    Chartiers	11
"    black oxide	11
"    sulphate	12
Crackers, cannon	12
"    Chinese	125
"    English	148
"    flash	87
Crimping	129
Designing	38
Devil among the tailors	48
Dextrine	92
Drying	13
	35

Electric spreaders	107
Exhibition fireworks	145
Flames, colored	139
Finishing	42
Flower pots	94
Formers	36
Flares	81
Fountains	93
Frame work	110
Fulminate of silver	131
Fuse, blasting	126
Fuses, shell	117
Fusees, railroad	57
Gerbs	93
Glue	16
Gold & Silver rain	107
Gum Arabic	16
Globe, revolving	146
Gun powder	16
Heading, rocket	77
Introduction	3
Ingredients	5
Labeling	47
Lampblack	6
Lances	111
Lancework	109
Magnesium	12
Matching	40
Match, candle & rocket	53
"    exhibition	50
"    frame	52
"    pipes	28
Mealpowder	16
Mines	91
Mine Bags	91
Mixing	23
Mortars	121
Manipulations	21
Niagara Falls	94
Orpiment	11
Paper caps	135
Parachutes	80
Paste	36
Paris green	10
Picric acid	18
Pigeons	86
Pin wheels	88
Pharaohs Serpent Eggs	137
Port fires	64
Pots, smoke	143
"    spark	142
Phosphorus	19
"    amorphus	19

I N D E X

Potash, bichromate	107
" chlorate	5
" nitrate	5
" perchlorate	5
Priming	42
Ramming	38
Realgar	11
Red gum	7
Rockets, sky	74
" standard sizes	31
" bombshell	79
" chain	82
Rockets, cones	77
" flights	83
" golden cloud	79
" liquid fire	80
" parachute	80
" prize cometic	79
" reporting	79
" short stick,	78
" stand	84
" willow tree	79
Roman candles,	66
" " ramming, hand	67
" " machine	69
" " standard sizes	30
Saw dust	54
Saxon wheels,	97
Saucissons	90
Shellac	7
Sheel-lac	7
Shells, plain	113
" double & tripple	117
" floral	113
" Japanese	120
" meteoric	114
Ship lights	64
Serpents	89
Smokeless fires	56
Smoke fireworks	142
" clouds, colored	143
" stars	143
" screens	143
Snake nests	138
Snake & butterfly	145
Son of a Gun	136
Soda oxalate	9
" met-antimonate	10
Sparklers	140
Starting fire,	94
Steel filings	14
Sticks, ruby & emerald	140

Stars, out	99
"    box	101
"    candle	103
"    compositions	103
"    exhibitions	104
"    granite	95
"    Japanese	100
"    molds	102
"    pumped, hand	102
"    plate	102
Strontia carbonate	8
"    nitrate	8
Stearine	7
Sugar of milk	7
Sulphur, flowers	6
"    flour	6
"    ground	6
"    washed	6
Tableau fires,	54
Thalium nitrate	7
Torches, aluminum	62
"    campaign	58
"    parade, Carnival	59
"    railroad	57
Tourbillions	85
Trailer stars,	108
Triangles	96
Torpedoes, Japanese	132
"    railroad	135
"    silver	131
Tying	47
Water fireworks,	141
"    beacons	141
"    divers	141
"    flying fish	142
"    mines	142
"    wheels	142
Wheels, rocket	145
"    saxon	97
"    vertical	97
Wasp light	95
Wiring	46
Whistling fireworks	135
Wrapping	43
Zinc	19

